

2015 *FIRST*[®] Robotics Competition (FRC[®]) Game Manual

1.0 RECYCLE RUSH Summary	1
2.0 The Arena.....	5
3.0 The Game	17
4.0 The Robot.....	28
5.0 The Tournament.....	49
6.0 Glossary.....	61



200 Bedford Street
Manchester, NH 03101, USA
<http://www.usfirst.org/frc>

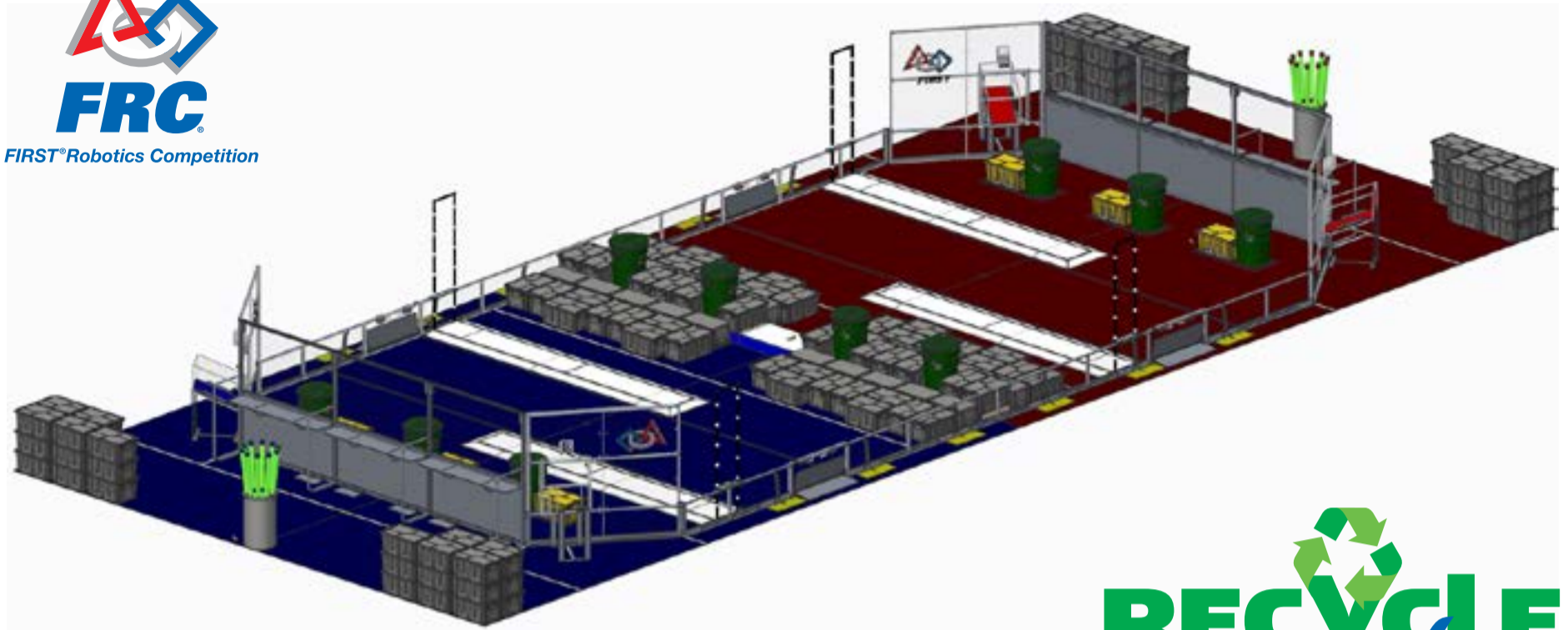
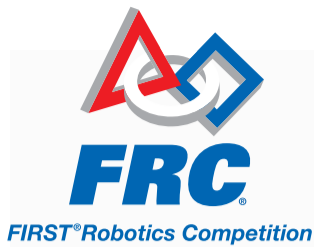
1

RECYCLE RUSH Summary

1.0	RECYCLE RUSH Summary	1
1.1	Game Summary	2
1.2	Manual Conventions	3
1.3	Team Updates	3
1.4	Question and Answer System	4

FIRST®, the FIRST® logo, FIRST® Robotics Competition, FRC®, FIRST® Tech Challenge, Coopertition®, Gracious Professionalism®, and RECYCLE RUSHSM are trademarks of the United States Foundation for Inspiration and Recognition of Science and Technology (FIRST®). FIRST® LEGO® League is a jointly held trademark of FIRST and the LEGO Group. LEGO® is a registered trademark of the LEGO Group. © 2015 FIRST. All rights reserved.

1 RECYCLE RUSH SUMMARY



1.1 Game Summary

RECYCLE RUSH is a recycling-themed game designed for the 2015 *FIRST* Robotics Competition (FRC). It is played by two Alliances of three Teams each. Alliances compete simultaneously to score points by stacking Totes on Scoring Platforms, capping those stacks with Recycling Containers, and properly disposing of Litter, represented by pool noodles, in designated locations. In keeping with the recycling theme of the game, all scoring elements used are reusable or recyclable by teams in their home locations or by *FIRST* at the end of the season.

The 27 ft. by 54 ft. playing Field is bisected by a small Step which may not be climbed on or crossed by Robots. Thus each Alliance competes on their respective 26 ft. by 27 ft. side of the Field.

Each RECYCLE RUSH Match begins with a 15-second Autonomous Period in which Robots operate independently of their drivers. During this period, Robots attempt to move themselves, their Yellow Totes, and their Recycling Containers into the area between the scoring platforms, called the Auto Zone. Additional points are awarded if the Yellow Totes are arranged in a single stack. Points for this period are shown in Table 1-1.

Table 1-1: Auto Point Values

Action	Value
ROBOT SET	4
TOTE SET	6
CONTAINER SET	8
STACKED TOTE SET	20

During the remaining 2 minutes and 15 seconds of the Match, called the Teleop Period, Robots are controlled remotely by student drivers located behind the walls at the ends of the Field. Teams on an Alliance work together to place as many Totes on their Scoring Platforms as possible. Alliances earn additional points for Recycling Containers placed on the scored Totes, with Recycling Containers at greater heights earning more points.

Alliances also earn points for disposing of their Litter in either their Landfill Zone (the area next to the Step marked by the white line) or placing Litter in or on scored Recycling Containers. Alliances that leave unscored Litter marked in the other Alliance's color on their side of the Field at the end of the match add points to the score of the other Alliance, as it is considered unprocessed and not properly disposed.

Alliances have an opportunity to earn “Coopertition Points” by coordinating with the other Alliance in the Match. Coopertition Points are awarded if, at some point in the Match, there are at least four Yellow Totes on the Step simultaneously. Coopertition Points are doubled if the Alliances arrange at least four of those Yellow Totes in a single stack on the Step.

Points for the Match are awarded based on the state of the scored objects at the end of the Match (with the exception of Coopertition Points, which can be earned at any point during the Match). Point values are shown in Table 1-2.

Table 1-2: TELEOP Point Values

Action	Value
Scored Gray TOTE	2 per TOTE
Scored RECYCLING CONTAINER	4 per LEVEL
LITTER Scored in/on RECYCLING CONTAINER	6 per RECYCLING CONTAINER
LITTER Scored in LANDFILL ZONE	1 per LITTER
UNPROCESSED LITTER Bonus	4 per LITTER
COOPERTITION SET*	20 for each ALLIANCE
COOPERTITION STACK*	40 for each ALLIANCE

**COOPERTITION SETS and COOPERTITION STACKS will not receive points during the Playoff MATCHES.*

To rank well during qualification matches, and advance through the playoff matches to the finals, teams will want to work to maximize their score for each match. Except for the final matches, winners of individual matches will not be declared, as this has no direct bearing on tournament performance in RECYCLE RUSH.

1.2 Manual Conventions

Specific methods are used throughout this section to highlight warnings, cautions, key words and phrases. These conventions are used to alert the reader to important information and are intended help teams in constructing a Robot that complies with the rules in a safe manner.

Key words that have a particular meaning within the context of the 2015 *FIRST* Robotics Competition and RECYCLE RUSH are defined in [Section 6: Glossary](#), and indicated in ALL CAPITAL letters throughout this text.

References to other sections of this manual, the Administrative Manual, or external articles appear in *italics*.

The rule numbering scheme uses an indication of the section in which the rule is stated plus a serial numbering system. The Game rules begin with “G,” the Robot Rules begin with “R,” and the Tournament Rules begin with “T”. References to specific rules use this scheme (e.g. “G1” is the first rule in [Section 3: The Game](#)).

Warnings, cautions and notes appear in blue boxes. It is strongly recommended that you pay close attention to their contents as they’re intended to provide insight into the reasoning behind a rule, helpful information on understanding or interpreting a rule, and/or possible “best practices” for use when implementing systems affected by a rule.

While blue boxes are part of the manual, they do not carry the weight of the actual rule (if there is an inadvertent conflict between a rule and its blue box, the rule supersedes the language in the blue box).

1.3 Team Updates

Team Updates are used to notify the FRC community of revisions to the official season documentation (e.g. the manual, field drawings, etc.) or important season news. Between Kickoff and Stop Build Day, Team Updates are posted each Tuesday and Friday. Between Stop Build Day and the week before the *FIRST* Championship, Team Updates are posted each Tuesday. Team Updates are posted at <http://www.usfirst.org/frc/teamupdates> and are generally posted before 5 pm, Eastern Time.

Generally, Team Updates will follow the following convention:

- A. Additions will be highlighted in yellow. **This is an example.**
- B. Subtractions will be indicated with a strike-through. ~~This is an example.~~
- C. Notes that are added for clarity or explanation for the change but are not retained as part of the manual appear in bold-italic. ***This is an example.***

1.4 Question and Answer System

Questions about the Administrative or Game Manuals may be asked to *FIRST* using the official Question and Answer System (aka “the Q&A”). Details on the Q&A can be found at <http://www.usfirst.org/frc/q-a>. The Q&A is intended to help clarify rules and sometimes the responses result in revisions to the text in the official manual (which is communicated using Team Updates).

The Q&A is not a resource to get rulings on hypothetical Match strategies or situations or a design review of a Robot system for legality. The responses in the Q&A do not supersede the text in the manual, although every effort will be made to eliminate inconsistencies between the two. While responses provided in the Q&A may be used to aid discussion and debate at each event, per [Section 5: The Tournament](#), the Head Referee and Lead Robot Inspector are the ultimate authority on game rules and Robot rules respectively. If you have concerns about trends of enforcement of rules by these volunteer authorities, please notify *FIRST* using frcteams@usfirst.org.

2

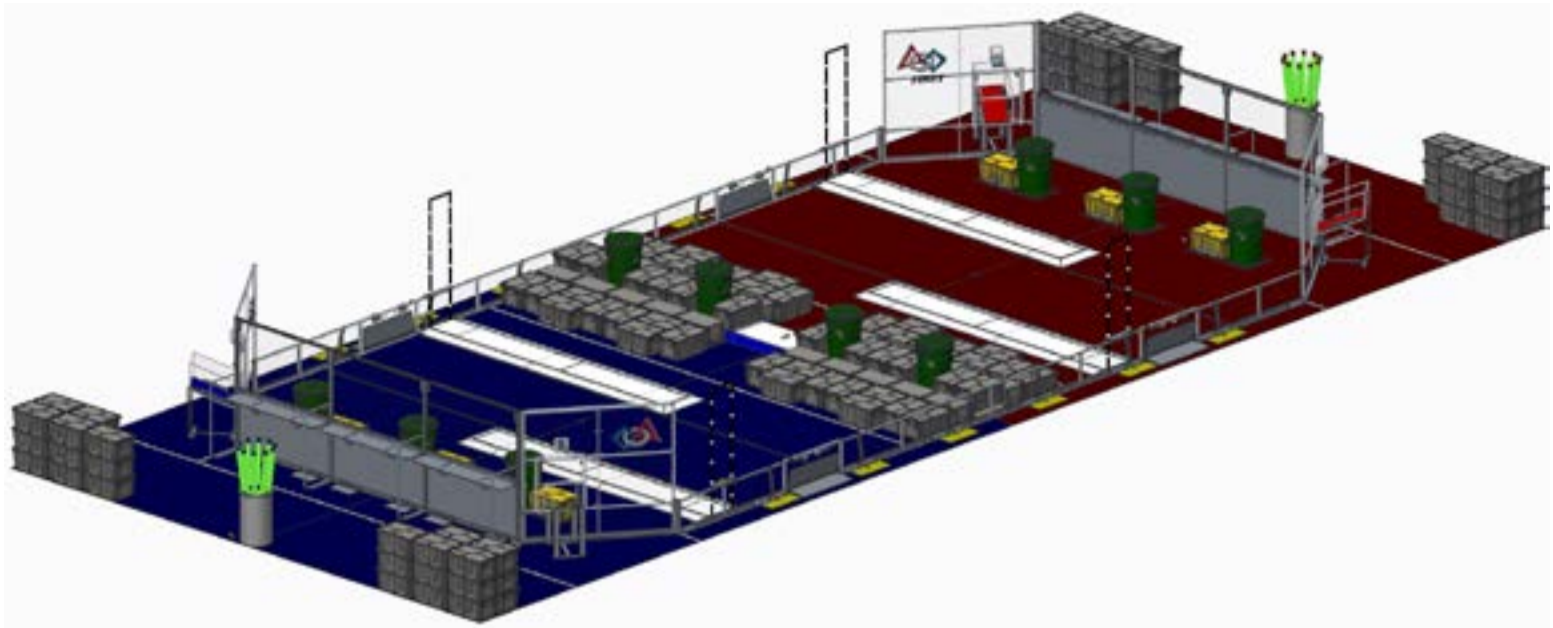
The Arena

2.0	The Arena	5
2.1	FIELD	6
2.1.1	GUARDRAIL	6
2.1.2	ALLIANCE WALL	7
2.1.3	SCORING PLATFORMS	7
2.1.4	STEP	8
2.1.5	Zone Markings	9
2.1.6	The Landmark	9
2.1.7	Vision Guides	10
2.2	ALLIANCE STATIONS	10
2.2.1	PLAYER STATIONS	10
2.2.2	HUMAN PLAYER STATION	11
2.2.3	HUMAN PLAYER ZONE	12
2.3	Game Elements	12
2.3.1	TOTES	12
2.3.2	RECYCLING CONTAINERS	14
2.3.3	LITTER	16
2.4	The FIELD Management System	16

FIRST®, the FIRST® logo, FIRST® Robotics Competition, FRC®, FIRST® Tech Challenge, Coopertition®, Gracious Professionalism®, and RECYCLE RUSHSM are trademarks of the United States Foundation for Inspiration and Recognition of Science and Technology (FIRST®). FIRST® LEGO® League is a jointly held trademark of FIRST and the LEGO Group. LEGO® is a registered trademark of the LEGO Group. © 2015 FIRST. All rights reserved.

2 THE ARENA

Figure 2-1: RECYCLE RUSH FIELD and surrounding elements



This section of the *2015 FRC Game Manual* presents an overview of the RECYCLE RUSH ARENA. RECYCLE RUSH is played by two (2) ALLIANCES of three (3) Teams each who compete simultaneously to score points by stacking TOTES, placing RECYCLING CONTAINERS on top of scored TOTES, and disposing of LITTER.

The ARENA includes all elements of the game infrastructure that are required to play RECYCLE RUSH: the FIELD, the ALLIANCE STATIONS, the game elements, and all equipment needed for FIELD control, ROBOT control, and scorekeeping.

The competition ARENA is a modular construction that is assembled, used, disassembled, and shipped many times during the competition season. It will undergo wear and tear. The ARENA is designed to withstand rigorous play and frequent shipping, and every effort is made to ensure that the ARENAS are consistent from event to event. However, as the ARENA is assembled in different venues by different event staff, some small variations do occur. For details regarding assembly tolerances, please refer to the [2015 ARENA Layout and Marking Drawing](#). Successful Teams will design ROBOTS that are insensitive to these variations.

Illustrations included in this section are for a general visual understanding of the RECYCLE RUSH ARENA, and dimensions stated in the manual are nominal. Please refer to the official FIELD drawings for exact dimensions and construction details. The official FIELD drawings, CAD models, and drawings for low-cost versions of the important elements of the RECYCLE RUSH ARENA are posted on the [2015 Official FIRST Field Drawings & Models](#) web page.

2.1 FIELD

The FIELD for RECYCLE RUSH is a 27 ft. by 54 ft. carpeted area, bound by and including GUARDRAILS and two (2) ALLIANCE WALLS. The FIELD is bisected by a STEP. The carpet used for each half of the FIELD matches the color of the respective PLAYER STATIONS (Shaw Floors, Philadelphia Commercial, Neyland II 20, 50510, “Polar Express” and “Capital Red”).

There are two versions of GUARDRAILS and ALLIANCE WALLS that will be used at competitions. One is the design that has been used at FRC competitions for several years and matches the design depicted in the [2015 Official FIRST Field Drawings & Models](#). The other was designed and is sold by AndyMark. While the designs are slightly different, the critical dimensions, performance, and expected user experience between the two is comparable. All Regional and Championship assemblies will use the traditional *FIRST* design. Teams may contact their local District leadership for details on which assembly will be used at their District event. Detailed drawings for the AndyMark design are posted on the [AndyMark](#) website. All illustrations in the game manual show the traditional field design.

The GUARDRAIL and the ALLIANCE WALL collectively define the borders of the FIELD.

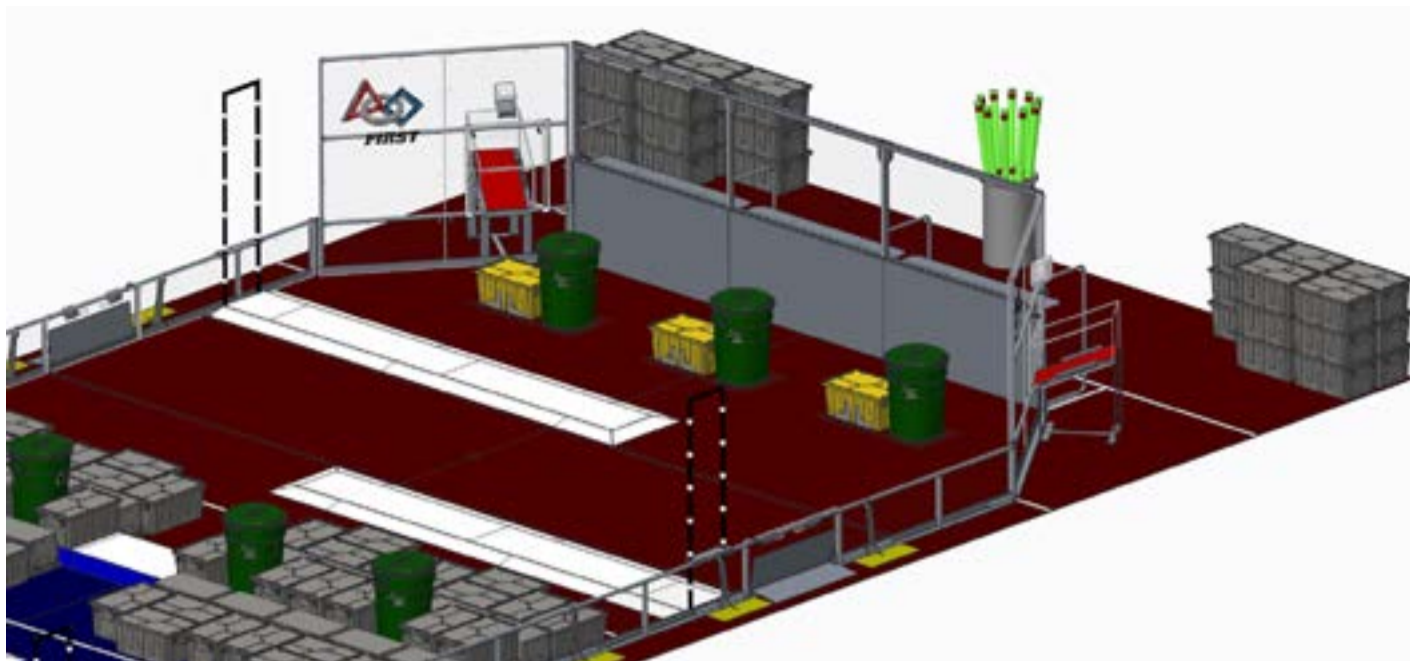
2.1.1 GUARDRAIL

The GUARDRAIL is a system that consists of a transparent polycarbonate shields supported on the top and the bottom by aluminum extrusion. The GUARDRAIL is intended to help prevent ROBOTS, in whole or in part, from inadvertently exiting the FIELD during a MATCH.

There are four (4) gates in the GUARDRAIL that allow access to the FIELD for placement and removal of ROBOTS. The gates are a minimum of 3 ft. 2 in. wide and are closed and shielded during the MATCH.

2.1.2 ALLIANCE WALL

Figure 2-2: ALLIANCE WALL



Each end of the FIELD has an ALLIANCE WALL that is 6 ft. 6 in. tall, and consists of three (3) PLAYER STATIONS and two (2) HUMAN PLAYER STATIONS. Both PLAYER STATIONS and HUMAN PLAYER STATIONS are detailed in [Section 2.2: ALLIANCE STATIONS](#).

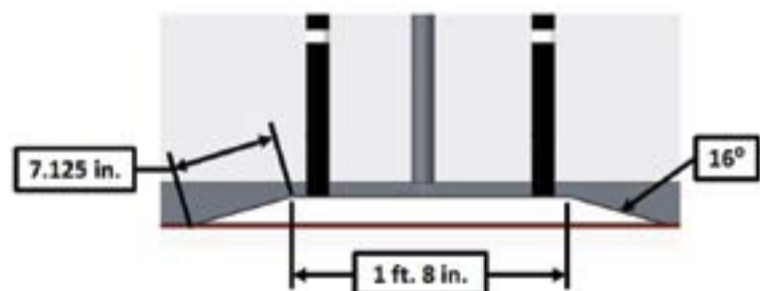
2.1.3 SCORING PLATFORMS

Each ALLIANCE has two (2) SCORING PLATFORMS. Each SCORING PLATFORM is 1 ft. 8 in. wide, 2 in. tall, and 15 ft. 7 in. long. Each SCORING PLATFORM is a plywood base covered in White HDPE. Along both long edges of the SCORING PLATFORM there are Platform Ramps. The Platform Ramps are also made from White HDPE, but are not considered part of the SCORING PLATFORM. One edge of the Platform Ramp is mounted to the SCORING PLATFORM while the other is taped to the carpet using White or ALLIANCE-colored gaffers tape, depending on which edge is being secured. The result is a 16-degree, 7.125 in. incline. There is a shorter ramp on the short edge of the SCORING PLATFORM.

Figure 2-3: SCORING PLATFORM Size

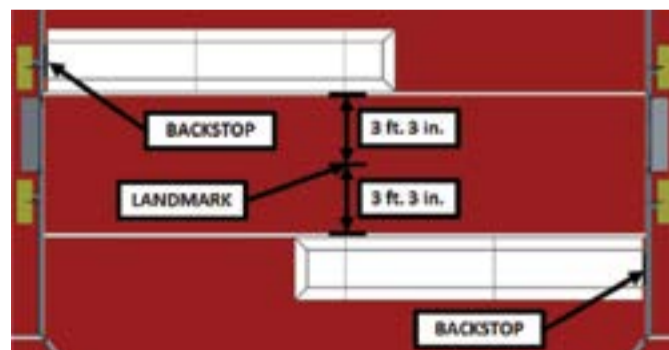


Figure 2-4: SCORING PLATFORM Geometry



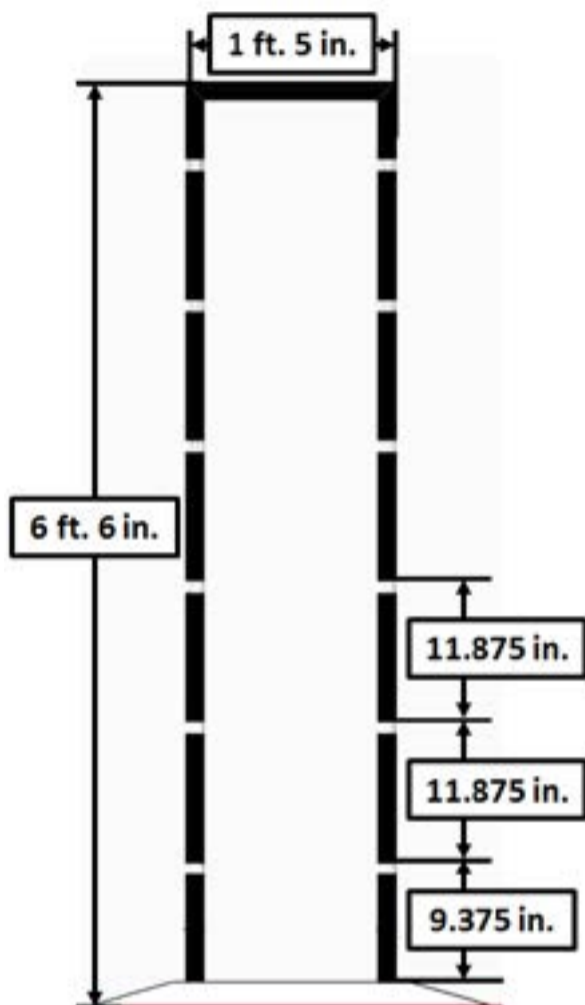
Each SCORING PLATFORM is adjacent to a BACKSTOP and positioned such that the bottom edge of the Platform Ramp is 3 ft. 3 in. from the center of the Landmark. Please see Figure 2-5 for more details.

Figure 2-5: SCORING PLATFORM Location



The BACKSTOP is meant to prevent TOTES and RECYCLING CONTAINERS from falling outside of the FIELD and may also be used to back TOTE stacks. The BACKSTOP is constructed of 1.25 in. Schedule 40 aluminum pipe. It is 6 ft. 6 in. tall and 1 ft. 5 in. wide. It is painted black and has graduations (indicated by White gaffers tape). The lowest graduating is such that the top edge of the tape is 9.375 in. from the top surface of the SCORING PLATFORM and then spaced every 11.875 in. The graduations are to help Teams and FIELD staff determine the correct LEVEL for each RECYCLING CONTAINER scored.

Figure 2-6: BACKSTOP Geometry



2.1.4 STEP

The STEP is a wooden platform that bisects the FIELD. It is painted white and is 6.25 in. tall and 2 ft. 1 in. wide. Mounted to the sides of the STEP facing each ALLIANCE WALL is a 0.25 in. thick by 6.625 in. tall HDPE sheet (colored to match the ALLIANCE). This HDPE forms a .375 in. lip along both sides of the STEP. This lip is to help prevent the TOTES from being pushed off the STEP too easily.

Figure 2-7: STEP Geometry

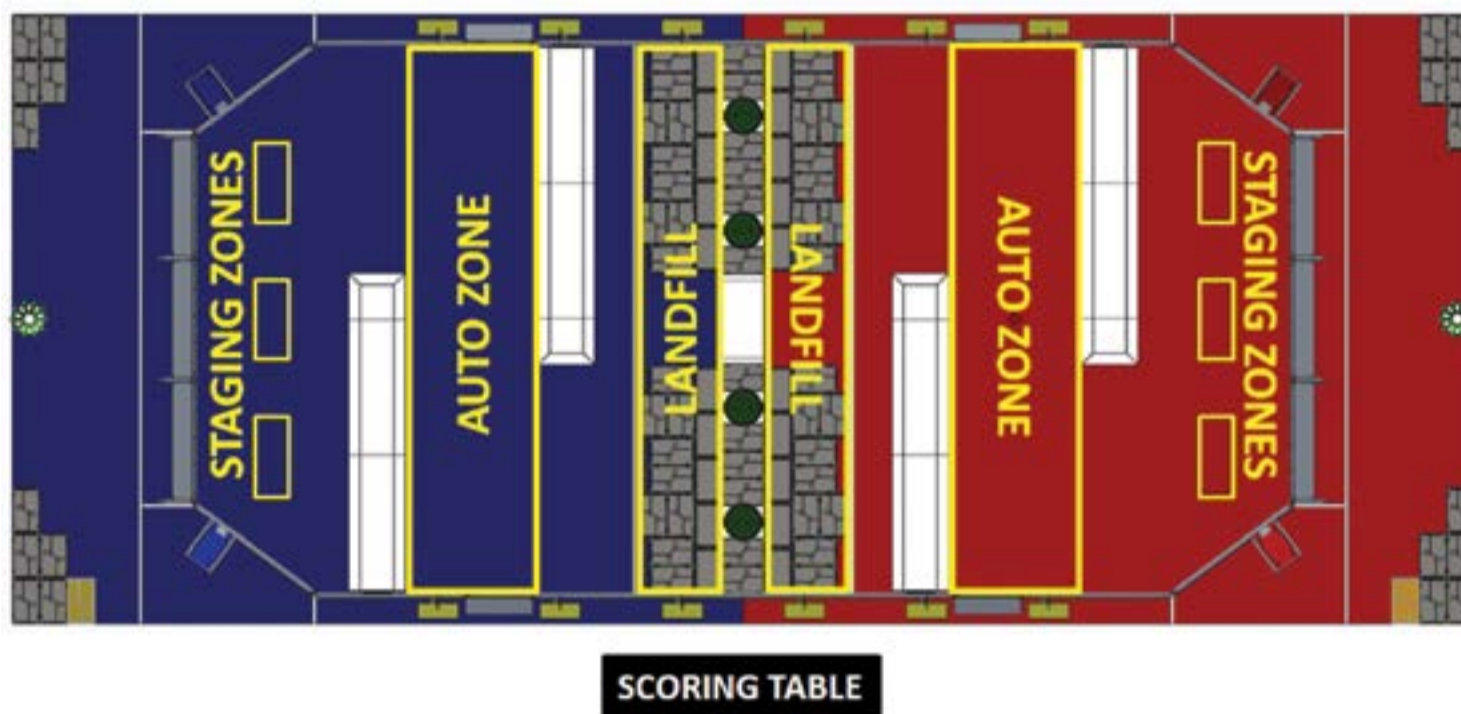


2.1.5 Zone Markings

Each ALLIANCE'S side of the FIELD contains the following zones:

- **AUTO ZONE:** Marked by, but does not include, 2 in. lines of Burgundy or Navy gaffers tape corresponding to the ALLIANCE COLOR, each AUTO ZONE is a 6 ft. 2 in. wide infinitely tall volume that spans the width of the field and is located between each ALLIANCE'S Platform Ramps (each edge is 3 ft. 1 in. from the Landmark).
- **LANDFILL ZONE:** Bounded by, but does not include, the STEP, GUARDRAILS, and a 2 in. line of White gaffers tape running between the GUARDRAILS on either side of the FIELD. Each LANDFILL ZONE is an infinitely tall volume that extends 4 ft. 3 in. from the edge of the STEP towards their ALLIANCE WALL.
- **STAGING ZONES:** Each ALLIANCE has three (3) STAGING ZONES that are used to position their three (3) RECYCLING CONTAINERS and Yellow TOTES on their half of the FIELD. The STAGING ZONES are boxes marked by 2 in. gaffers tape corresponding to the ALLIANCE color. The edge of the tape is 8 ft. 11 in. from the Landmark. The middle box is centered between the GUARDRAILS, and there is a 2 ft. 9 in. gap in between it and the other two (2) boxes. The STAGING ZONES include the tape, and are 4 ft. long by 1 ft. 9 in. wide.

Figure 2-8: Zone Markings

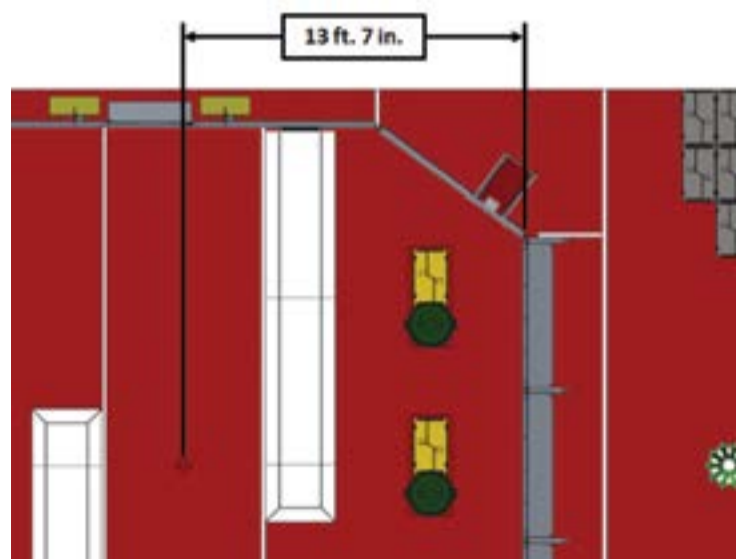


2.1.6 The Landmark

Each AUTO ZONE contains one (1) Landmark, which is centered across the width of the zone and located 13 ft. 7 in. from the ALLIANCE WALL. The Landmark is a 4 in. by 4 in. "+" sign defined by 2 in. gaffers tape that matches the ALLIANCE color.

The Landmark is not intended to be a vision target. Instead, it is intended to give be a common reference point for DRIVE TEAMS to use when coordinating gameplay strategies, such as building a STACKED TOTE SET.

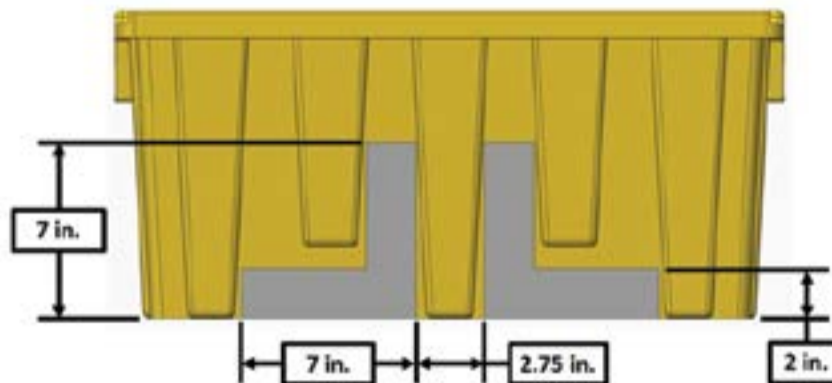
Figure 2-9: Landmark Location



2.1.7 Vision Guides

Each Yellow TOTE is marked with eight (8) strips of 2 in. retro-reflective material (3M 8830 Silver Marking Film) adhered to the long sides of the TOTE and assembled such that two (2) mirrored “L” shapes are formed as demonstrated below.

Figure 2-10: Vision Guides on the Yellow TOTE

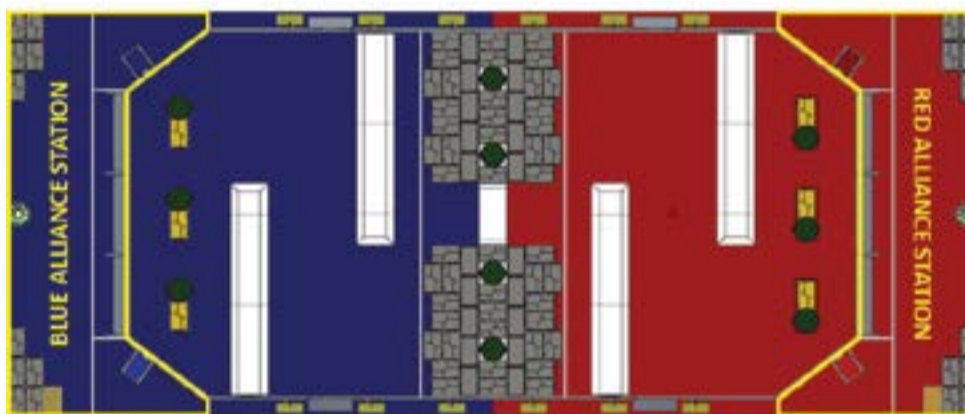


2.2 ALLIANCE STATIONS

Red and Blue ALLIANCE STATIONS are located on each end of the FIELD, behind the ALLIANCE WALLS, and are bounded by the edges of the carpet, the ALLIANCE WALL, and White gaffers tape, which extends from the end of each GUARDRAIL to the edge of the carpet. The STARTING LINE is the width of the ALLIANCE STATION and is marked with 2 in. White gaffers tape that is 2 ft. 4 in. from the PLAYER STATIONS.

Each ALLIANCE STATION contains one (1) Bin which contains LITTER. Each ALLIANCE STATION also contains TOTES. Details of the staging of these game elements are included in [Section 2.3: Game Elements](#).

Figure 2-11: ALLIANCE STATIONS



2.2.1 PLAYER STATIONS

Each ALLIANCE WALL includes three (3) PLAYER STATIONS. Each PLAYER STATION is made from a 3 ft. tall diamond plate panel base topped with a 3 ft. 6 in. tall transparent plastic panel. An aluminum shelf is attached to each PLAYER STATION to support the DRIVE TEAM'S OPERATOR CONSOLE. The shelf is 5 ft. 9 in. wide and 1 ft. deep. There is a 4 ft. 6 in. long by 2 in. wide strip of hook-and-loop tape (“loop” side) along the center of the support shelf that may be used to secure the OPERATOR CONSOLE to the shelf.

Each PLAYER STATION contains the following electronic components for Teams:

- **One Ethernet Cable.** This cable attaches to the Ethernet port of the OPERATOR CONSOLE and provides connectivity to the ARENA network.
- **One 120VAC NEMA 5-15R power outlet.** It is located on the right side of each PLAYER STATION shelf. The outlet is protected by a 3-Amp circuit breaker and can be used to power the OPERATOR CONSOLE. DRIVE TEAMS are responsible for monitoring their power consumption as a tripped breaker in the outlet does not constitute an ARENA fault.
- **One Emergency Stop (E-Stop) button.** It is located on the left side of the PLAYER STATION shelf and should be used to deactivate a ROBOT if necessary.

- **One Team sign.** This displays the Team number and is located at the top of each PLAYER STATION.
- **One Team LED.** This indicates ALLIANCE color, ROBOT status, and E-Stop status and is centered at the top of each PLAYER STATION. Team LED states include:
 - Solid - indicates that the ROBOT is connected and enabled. This will only happen during a MATCH.
 - Blinking - indicates that either the Field Management System (FMS) is preset for the MATCH or because it's during a MATCH and a ROBOT has lost connectivity.
 - Off – indicates that MATCH has not started yet, but the ROBOT is linked and disabled by FMS.

When the amber colored LED is lit, it means that the E-stop button has been pressed.

- **One Timer (in the middle PLAYER STATION only).** This displays the official time remaining in AUTO and TELEOP.
- Competition ARENA hardware and wiring. Mostly located below the center PLAYER STATION shelf.
- **One (1) Phillips Color Kinetics iColor Flex LMX LED light string.** Indicates information as defined in Table 2-1.

Table 2-1: Light States and Meanings

Light State	Meaning
Green	FIELD is safe to enter
Off	FIELD is ready for the MATCH to begin, all personnel should be off the FIELD at this time.
Yellow	MATCH is in AUTO
ALLIANCE color (Red or Blue)	MATCH is in TELEOP
ALLIANCE color with a White middle section	ALLIANCES have scored a COOPERTITION SET
White	ALLIANCES have scored a COOPERTITION STACK
Pulse at 0.5 Hz	MATCH is in its final twenty (20) seconds

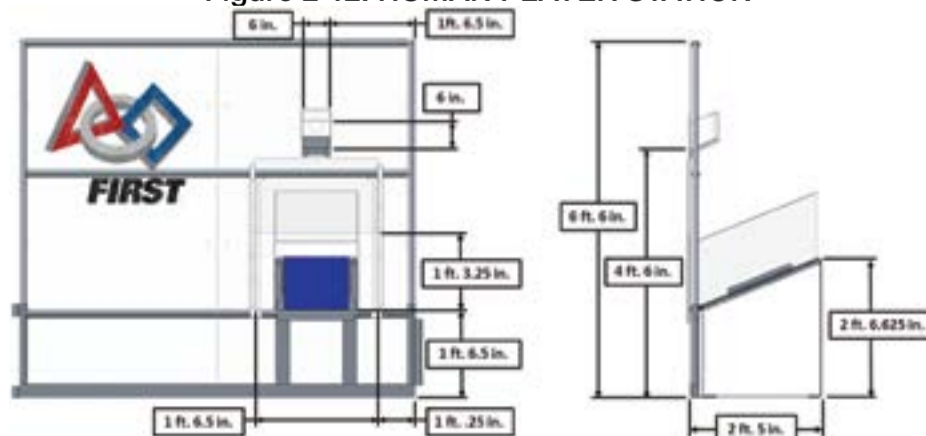
2.2.2 HUMAN PLAYER STATION

The HUMAN PLAYER STATIONS connect the end PLAYER STATIONS to the GUARDRAILS. Each HUMAN PLAYER STATION is constructed of two (2) 6 ft. 6 in. tall by 3 ft. 7 in. wide clear polycarbonate panels, attached to an aluminum frame with cable ties, and the CHUTE DOOR. The panel adjacent to the GUARDRAIL is a solid panel adorned with the *FIRST* logo.

The panels adjacent to the PLAYER STATIONS each have two openings, one for the TOTE CHUTE, the other for the LITTER CHUTE. Each TOTE CHUTE opening is 1 ft. 3.25 in. tall by 1 ft. 6.5 in. wide, with the bottom of the opening located 1 ft. 6.5 in. above the carpet. The TOTE CHUTE is installed behind the TOTE CHUTE opening (i.e. on the outside of the FIELD) and consists of an 2 ft. 6 in. long ramp of HDPE, at a 22 degree incline, with a upper edge that is 2 ft. 6.625 in. from the floor. The ramp is covered with a shield of clear polycarbonate. A clear polycarbonate CHUTE DOOR is installed over the TOTE CHUTE opening and prevents a TOTE in the TOTE CHUTE from sliding out into the playing FIELD. Once a TOTE is loaded in to the TOTE CHUTE, the CHUTE DOOR can be opened using a handle located on either side of the CHUTE DOOR. This allows a TOTE loaded in the TOTE CHUTE to slide onto the FIELD.

Centered above the TOTE CHUTE is the LITTER CHUTE. The LITTER CHUTE is a 6 in. by 6 in. opening, with the bottom of the opening located 4 ft. 6 in. above the carpet. Behind the opening is an aluminum ramp that is 6.5 in. long set at a 22 degree angle. The ramp is covered with a clear polycarbonate shield. Teams feed the LITTER through a 2.875 in. diameter hole in the shield.

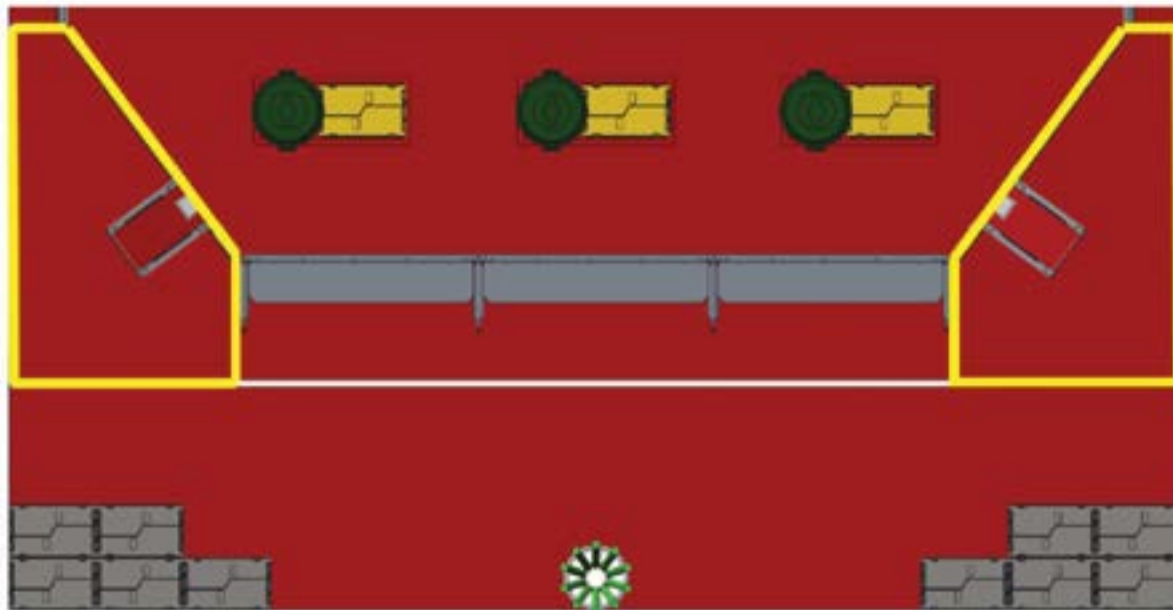
Figure 2-12: HUMAN PLAYER STATION



2.2.3 HUMAN PLAYER ZONE

The Red and Blue HUMAN PLAYER ZONES are located on each end of the FIELD, behind the ALLIANCE WALLS and each are bounded by the edge of the carpet, the HUMAN PLAYER STATION, the STARTING LINE, and White gaffers tape.

Figure 2-13: Red HUMAN PLAYER ZONES



2.3 Game Elements

RECYCLE RUSH is played with three (3) different types of game elements: TOTES, RECYCLING CONTAINERS, and LITTER.

2.3.1 TOTES

Each ALLIANCE has access to two (2) types of TOTES; Yellow TOTES (Pantone 109M) and Gray TOTES (Pantone 423M). Each TOTE is 26.9 in. long, 16.9 in. wide, 12.1 in. tall, and made of a rigid plastic. Each TOTE weighs approximately 7.8 lbs. The lids are secured closed using cable ties. TOTES are the same model (Orbis [FP243](#)) and colors as those that TEAMS received as part of their 2015 Kickoff Kits and are marked with the *FIRST* logo on both short ends of the TOTES. The TOTES are the same model (not same color or logo scheme) as those used for the 2014 Kickoff Kits. The Yellow TOTES are marked with retro-reflective tape, as described in the [Section 2.1.7: Vision Guides](#).

Please note that the Kit of Parts totes used from 2011 through 2013 were a different model ([Orbis FP242](#)).

Figure 2-14: Yellow and Gray TOTES (*FIRST* logo stamps not shown)

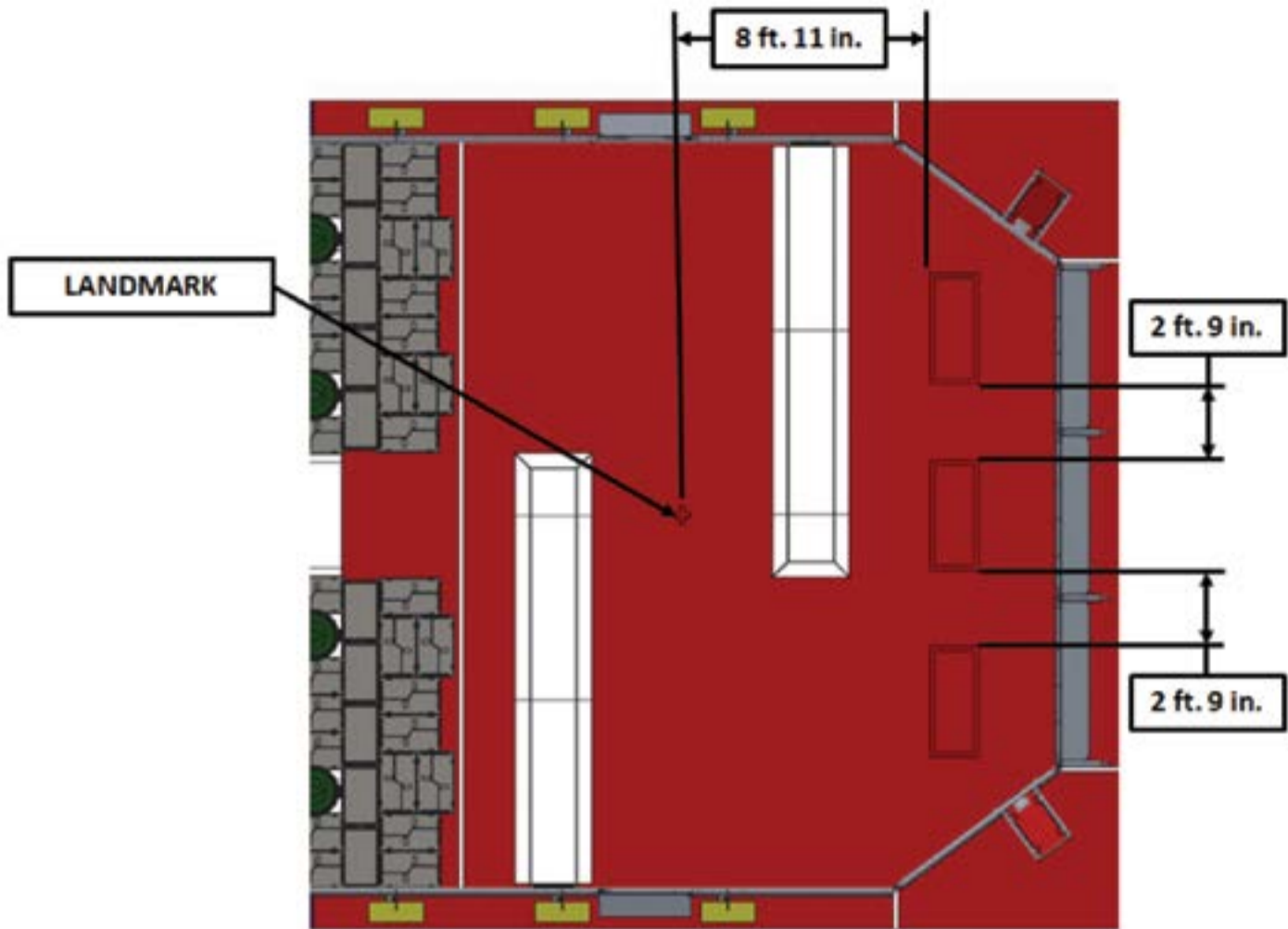


Each MATCH begins with 128 Gray TOTES and six (6) Yellow TOTES. The TOTES are staged before the MATCH in the following manner:

- A. Twelve (12) Gray TOTES are placed on the STEP.
- B. Twenty-eight (28) Gray TOTES are placed in each LANDFILL ZONE.
- C. Thirty (30) Gray TOTES are placed in each ALLIANCE STATION.
- D. One (1) Yellow TOTE is placed in each of the six (6) Taped Boxes described in [Section 2.1.5: Zone Markings](#).

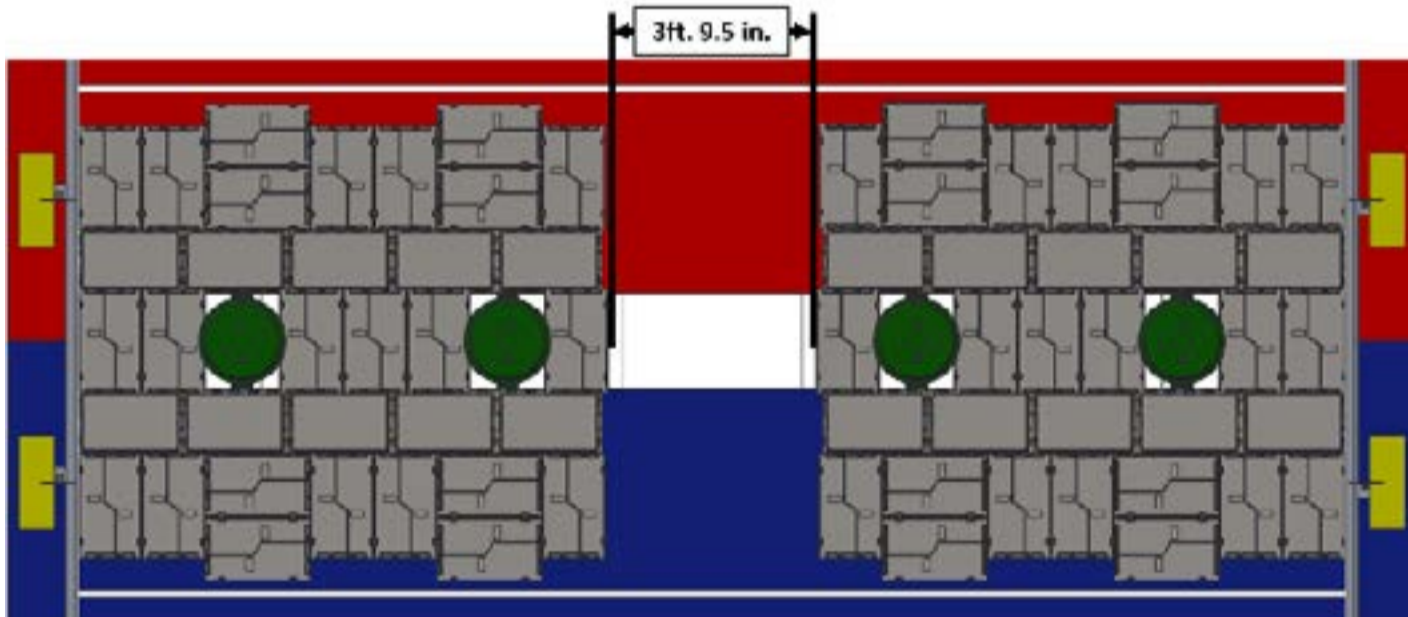
Teams may elect to move some or all of the Yellow TOTES into the ALLIANCE STATION prior to the start of the MATCH per [Section 3.1.4: MATCH Logistics](#).

Figure 2-15: STAGING ZONE Locations



The Gray TOTES on the STEP are positioned right side up, such that the longer side of the tote runs parallel to the GUARDRAIL, separated by RECYCLING CONTAINERS as demonstrated in Figure 2-16 below.

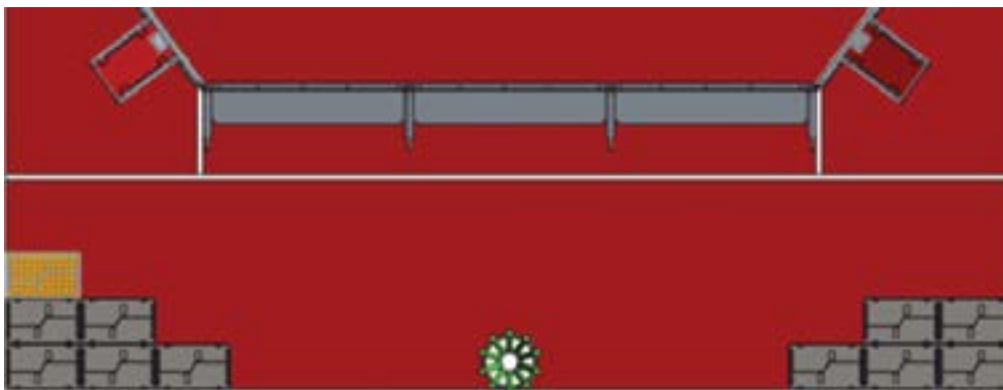
Figure 2-16: Gray TOTE Locations on the STEP



There are twenty-eight (28) Gray TOTES in each ALLIANCE LANDFILL ZONE: the row closest to the STEP is made up of two (2) sets of five (5) Gray TOTES that are upside down with the short side parallel to the GUARDRAIL. Adjacent to the row of upside down Gray TOTES are two (2) sets of nine (9) Gray TOTES which are right side up, with pairs of Gray TOTES in alternating orientations, shown in the Figure 2-16. All sets of Gray TOTES are justified to the GUARDRAIL, and are placed in order, from the GUARDRAIL toward the center of the FIELD during setup.

TOTES in each ALLIANCE STATION are stacked in ten (10) stacks of three (3) TOTES each as is shown in Figure 2-17. There is an optional location for up to three (3) stacked Yellow TOTES on the same side of the FIELD as the Scoring Table.

Figure 2-17: Gray TOTE Locations in the ALLIANCE ZONE



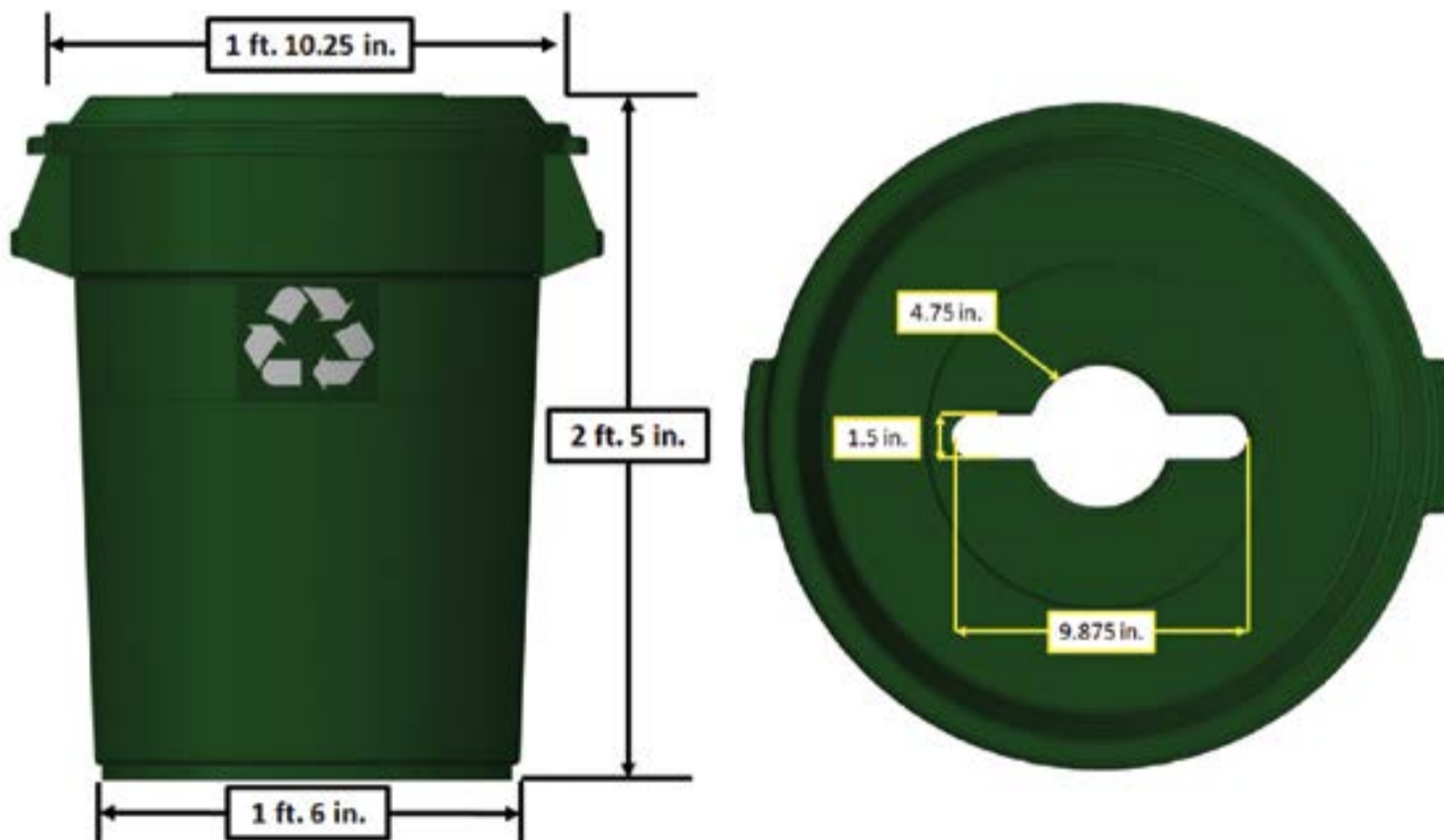
TOTES will be removed from play at the end of the MATCH if, in the judgment of the Head Referee, the TOTE is unsuitable for gameplay. Examples include but are not limited to: lids broken off, large cracks that weaken rigidity, and large holes. Lids that come open but are still attached will be reclosed and secured with cable ties before the start of the next MATCH.

Damaged TOTES count for scoring purposes as long as they remain largely intact and have lids still in place and closed. Examples of damage which do not make the TOTE ineligible for scoring include, but are not limited to, obviously cracked plastic or broken-off handles.

2.3.2 RECYCLING CONTAINERS

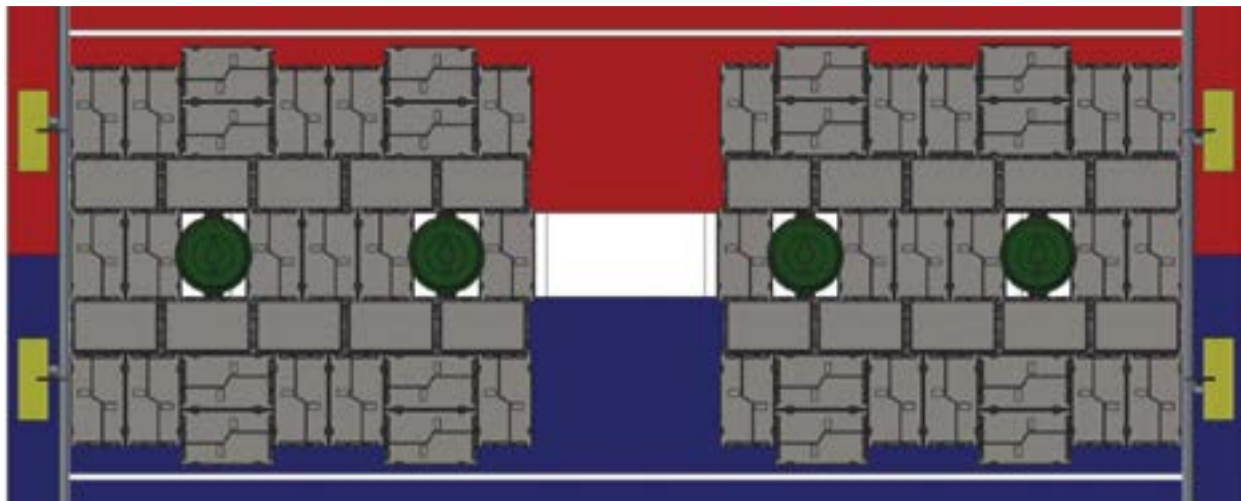
RECYCLING CONTAINERS are 32 gallon green Rubbermaid™ Recycling Containers with “single stream recycling” style lids. The part number for a non-*FIRST* branded can that is the same model and color as those used in competition is 1788472. Each RECYCLING CONTAINER is 28.8 in. tall (height includes lid), has a diameter of 21.9 in., and weighs approximately 8.65 lbs. The lids are also manufactured by Rubbermaid™ (part number 1788471) and weigh approximately 2 lbs. The lids are secured to the RECYCLING CONTAINERS using cable ties, and each lid has a 4.75 in. diameter hole in the center. Please see Figure 2-18 for full dimensions. A version of this container, the same size and make of the same material used in the competitions, but in a different color, is available with the part number FG263200GRAY.

Figure 2-18: RECYCLE CONTAINER Geometry



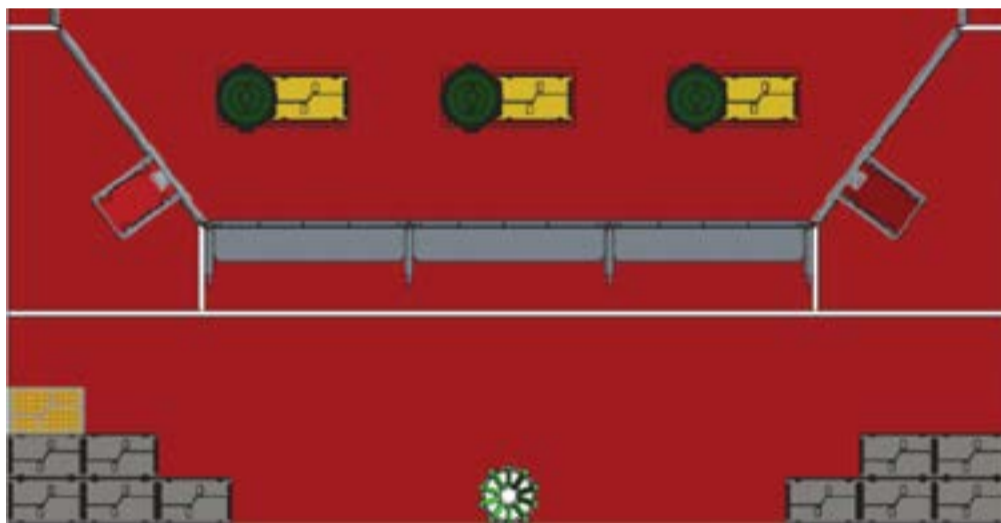
There are ten (10) RECYCLING CONTAINERS on the FIELD at the start of the MATCH. There are four (4) on the STEP and one (1) in each STAGING ZONE. The RECYCLING CONTAINERS located on the STEP are distributed between TOTES as demonstrated in the Figure 2-19 below.

Figure 2-19: RECYCLE CONTAINER Locations on the STEP



Each RECYCLING CONTAINER is oriented such that the handles point at the ALLIANCES' PLAYER STATIONS, as seen in Figure 2-20. The RECYCLING CONTAINERS in the STAGING ZONES will always be to the left of the Yellow TOTE when viewed from the corresponding ALLIANCE STATION.

Figure 2-20: RECYCLE CONTAINER Locations in the STAGING ZONES



RECYCLING CONTAINERS are ineligible for scoring and will be removed from play at the end of the MATCH if, in the judgment of the Head Referee, the RECYCLING CONTAINER is unsuitable for gameplay. Examples include but are not limited to: lids completely broken off, large cracks that weaken rigidity, and large holes. Lids that come off but are otherwise not damaged will be reclosed and secured with cable ties before the start of the next MATCH.

Figure 2-21: LITTER



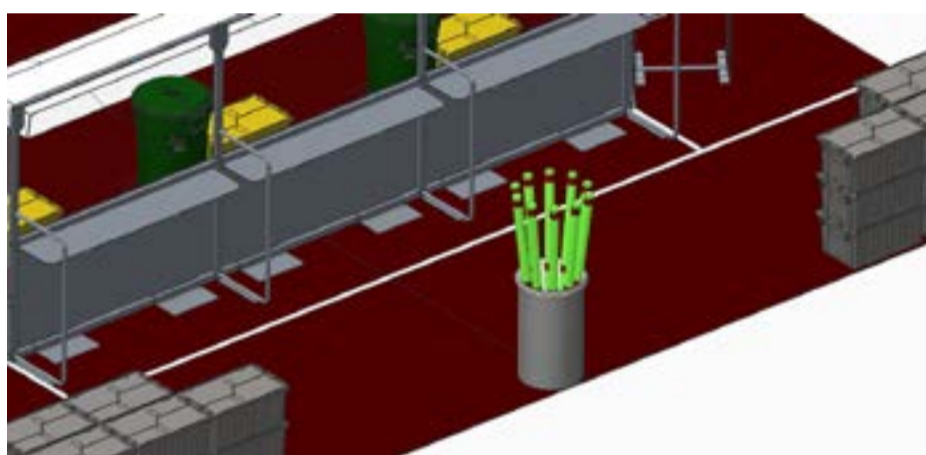
2.3.3 LITTER

Each LITTER is a solid core, green Pool Noodle, manufactured by Tundra (Part Number: SR20C). They are between 4 ft 7 in. and 4 ft. 11 in. in length and have an outside diameter of 2.6 in. Given that the manufacturing process for Pool Noodles is not tightly controlled and the Pool Noodles used and distributed for the 2015 season were made in different production runs, Teams should expect some variation in rigidity, length, diameter, and surface characteristics

Each ALLIANCE starts the MATCH with ten (10) LITTER, all of which are located in a white Bin. The LITTER is marked 1 in. from each end and in the middle with 2 in. “Red” and “Electric Blue” gaffers tape to match the ALLIANCE STATION in which it starts. The Bin is on the carpet and centered behind the middle PLAYER STATION such that back edge of the carpet is tangent to the Bin. The Bin is constructed from a [US Plastics Tamco 30 Gallon Polyethylene Tank \(Item #: 4031\)](#). It is 30.5 in. tall with a diameter of 17.75 in.

LITTER will be removed from play if, in the judgment of the Head REFEREE, the LITTER is unsuitable for gameplay. Examples include but are not limited to: the length shortened, or a chunk more than approximately 1.5 in. deep and 3 in. long is removed, or tape has been removed. Small cuts or small pieces removed will not cause LITTER to be replaced. Damaged LITTER counts for scoring purposes as long as the LITTER has at least two of the three 2-inch red or blue tape rings in place.

Figure 2-22: LITTER and Bin Starting Locations



2.4 The FIELD Management System

Once a DRIVE TEAM connects the Ethernet cable from their PLAYER STATION to their OPERATOR CONSOLE, the OPERATOR CONSOLE computer will begin to communicate with the FIELD Management System (FMS). Once connected to FMS, ports available are as follows:

- A. **TCP 1180:** Camera data from the roboRIO to the Driver Station (DS) when the camera is connected the roboRIO via USB, bi-directional.
- B. **TCP 1735:** SmartDashboard, bi-directional
- C. **UDP 1130:** Dashboard-to-ROBOT control data, uni-directional
- D. **UDP 1140:** ROBOT-to-Dashboard status data, uni-directional
- E. **HTTP 80:** Camera connected via switch on the ROBOT, bi-directional
- F. **HTTP 443:** Camera connected via switch on the ROBOT, bi-directional
- G. **UDP/TCP 554:** Real-Time Streaming Protocol for h.264 camera streaming, bi-directional
- H. **UDP/TCP 5800-5810:** Team Use, bi-directional

Teams may use these ports as they wish if they do not employ them as outlined above (i.e. TCP 1180 can be used to pass data back and forth between the ROBOT and the DS if the Team chooses not to use the camera on USB). Additional information about the FMS may be found on the *FIRST* website in the [FMS Whitepaper](#).

3

The Game

3.0	The Game	17
3.1	Overview	18
3.1.1	MATCH Timing	18
3.1.2	Scoring	18
3.1.3	Penalty Assignment	22
3.1.4	MATCH Logistics	22
3.2	Game Rules	23
3.2.1	Safety	23
3.2.2	Pre-MATCH and Post-MATCH	24
3.2.3	General Rules	25
3.2.4	AUTO Rules	26
3.2.5	ROBOT Actions	26
3.2.6	Human Actions	27

FIRST®, the FIRST® logo, FIRST® Robotics Competition, FRC®, FIRST® Tech Challenge, Coopertition®, Gracious Professionalism®, and RECYCLE RUSHSM are trademarks of the United States Foundation for Inspiration and Recognition of Science and Technology (FIRST®). FIRST® LEGO® League is a jointly held trademark of FIRST and the LEGO Group. LEGO® is a registered trademark of the LEGO Group. © 2015 FIRST. All rights reserved.

3 THE GAME

RECYCLE RUSH is played by two (2) ALLIANCES of three (3) Teams each who compete simultaneously to score points by stacking TOTES, placing RECYCLING CONTAINERS on top of stacked TOTES, and disposing of LITTER. This chapter contains two sections: the first section describes the Game and the second section describes the detailed rules by which competitors must abide.

3.1 Overview

Details such as the FIELD set up, MATCH execution, point values, etc. are defined in this section.

3.1.1 MATCH Timing

A MATCH is two (2) minutes and thirty (30) seconds long. The Autonomous Period (AUTO) is the first fifteen (15) seconds of the MATCH. The Teleoperated Period (TELEOP) is the remaining two (2) minutes and fifteen (15) seconds.

3.1.2 Scoring

Points are awarded for a variety of ALLIANCE accomplishments which include, but are not limited to: stacking TOTES on SCORING PLATFORMS, placing RECYCLING CONTAINERS on scored Gray TOTES, and “disposing” of LITTER by placing it in scored RECYCLING CONTAINERS, the LANDFILL ZONE, or throwing it onto the opposite side of the FIELD.

With the exception of UNPROCESSED LITTER, if the actions of one ALLIANCE cause any of the other ALLIANCE’S game elements that are in scoring position to no longer be in scoring position, the affected ALLIANCE will be credited points for the displaced game elements at the conclusion of the MATCH.

3.1.2.1 AUTO

During AUTO, each ALLIANCE can earn points for a ROBOT SET, TOTE SET or STACKED TOTE SET, and CONTAINER SET. A ROBOT SET occurs when all ROBOTS on an ALLIANCE move themselves to, and are fully contained by, their AUTO ZONE at the end of AUTO. A TOTE SET exists if all three (3) Yellow TOTES from an ALLIANCE are fully contained by the AUTO ZONE, but do not meet the requirements of a STACKED TOTE SET, at the end of AUTO.

A ROBOT SET requires all ROBOTS from an ALLIANCE who are playing in a particular MATCH in order to be scored. For example, if ROBOTS A, B and C are on an ALLIANCE, but ROBOT B is not on the FIELD for a particular MATCH (or has been DISABLED by the FIELD staff prior to the MATCH), the ROBOT SET only requires two (2) ROBOTS.

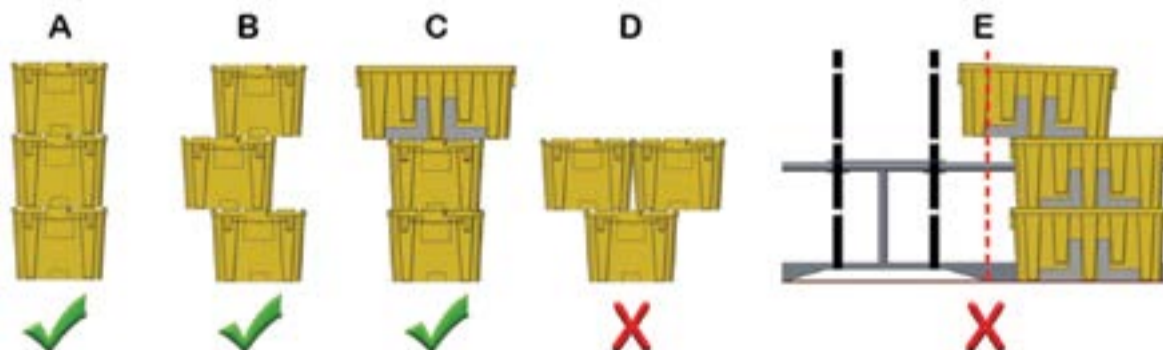
A CONTAINER SET exists if any three (3) RECYCLING CONTAINERS are fully contained by the AUTO ZONE at the end of AUTO.

A STACKED TOTE SET exists if all three (3) Yellow TOTES from an ALLIANCE are arranged such that, at the end of AUTO:

- A. the Yellow TOTES are stacked one on top of another in a single column,
- B. only the bottom-most Yellow TOTE is in contact with carpet in the AUTO ZONE,
- C. the entire structure is fully contained by the AUTO ZONE, and
- D. the entire structure is free of contact from ROBOTS

The following examples demonstrate three STACKED TOTE SETS and two assemblies that do not count as STACKED TOTE SETS. In the renderings below, it is assumed that examples A-D are entirely contained by the AUTO ZONE.

Figure 3-1: STACKED TOTE SETS



In the first three examples (A-C) of Figure 3-1 each assembly includes all three (3) Yellow TOTES that are stacked one on top of another in a single column, fully contained by the AUTO ZONE, and free of contact from ROBOTS. In the fourth example (D), the Yellow TOTES are not stacked one on top of another in a single column. In the final example (E, shown here with a super-imposed dotted line extending upwards from the edge of the AUTO ZONE tape) not all TOTES are fully contained by the AUTO ZONE.

During TELEOP, Yellow TOTES can only score as part of a COOPERTITION SET or a COOPERTITION STACK.

3.1.2.2 Coopertition

Both ALLIANCES are awarded points if a COOPERTITION SET or a COOPERTITION STACK is assembled on the STEP. A COOPERTITION SET exists when at least four (4) Yellow TOTES are fully supported by the STEP, but do not meet the requirements of a COOPERTITION STACK.

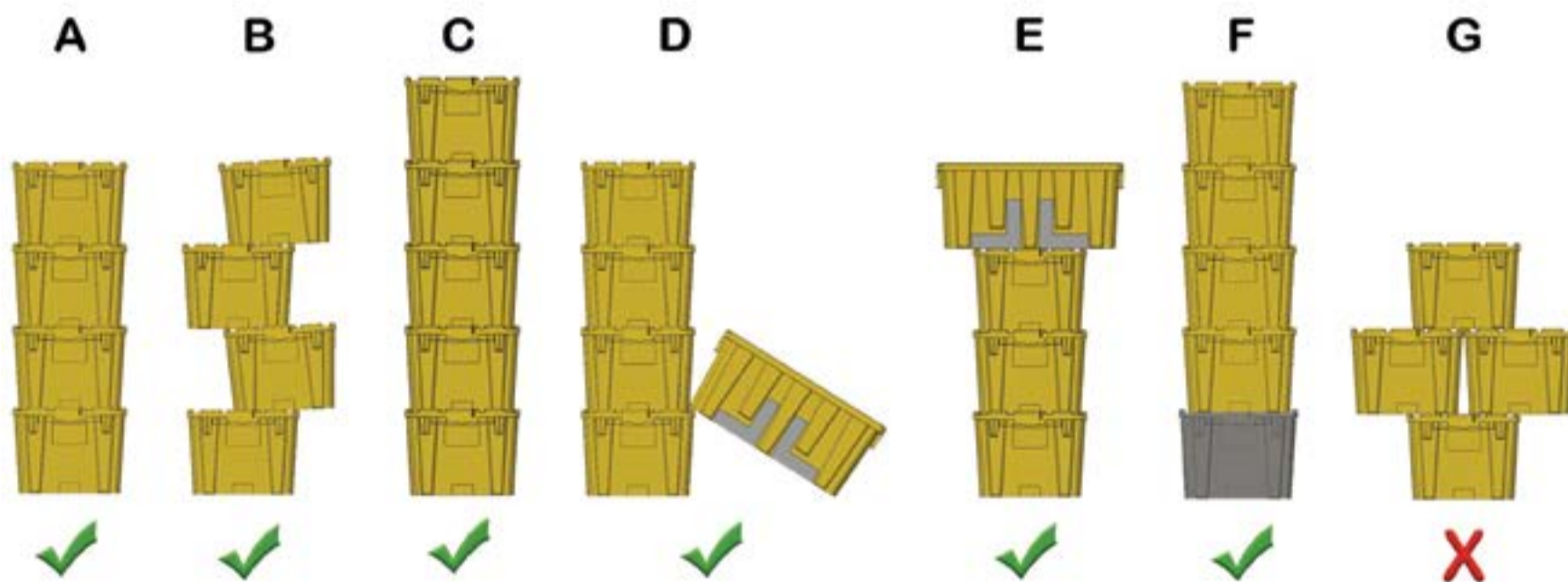
A COOPERTITION STACK exists if at least four (4) Yellow TOTES are arranged such that:

- A. they are stacked one on top of another in a single column,
- B. the structure is fully supported by the STEP, and
- C. the entire structure is free of contact from ROBOTS for at least three (3) seconds

“Support”, in reference to TOTES, for COOPERTITION, AUTO, and TELEOP, is transitive through other TOTES. For example, a Yellow TOTE is “fully supported by the STEP” if it is resting on top of another Yellow TOTE that is in turn resting directly on the STEP (and thus both Yellow TOTES are “fully supported” by the STEP).

Figure 3-2 demonstrates six COOPERTITION STACKS and one assembly that does not count as a COOPERTITION STACK. It is assumed that each assembly in Figure 3-2 is entirely supported by the STEP.

Figure 3-2: COOPERTITION STACKS



The first six examples (A through F) each include at least four (4) TOTES that are arranged in a single column, supported by the STEP (either directly or “through” a Gray TOTE), and free of contact from ROBOTS. In the seventh example (G), the TOTES are not arranged in a single column and are not be credited for a COOPERTITION STACK, but still satisfy the criteria of a COOPERTITION SET.

Unlike other points, which are awarded at either the end of the AUTO or TELEOP, points for a COOPERTITION SET or COOPERTITION STACK are awarded instantly upon successful completion. If points are awarded for a COOPERTITION SET and a COOPERTITION STACK is formed at a later time in the MATCH, the COOPERTITION SET will be upgraded and instead awarded points for a COOPERTITION STACK. The PLAYER STATION LED strings will indicate to the DRIVE TEAMS when credit has been awarded for a COOPERTITION SET or COOPERTITION STACK as described in [Section 2.2.1: PLAYER STATIONS](#).

ALLIANCES can earn points for either a COOPERTITION STACK or a COOPERTITION SET in a MATCH, but not both.

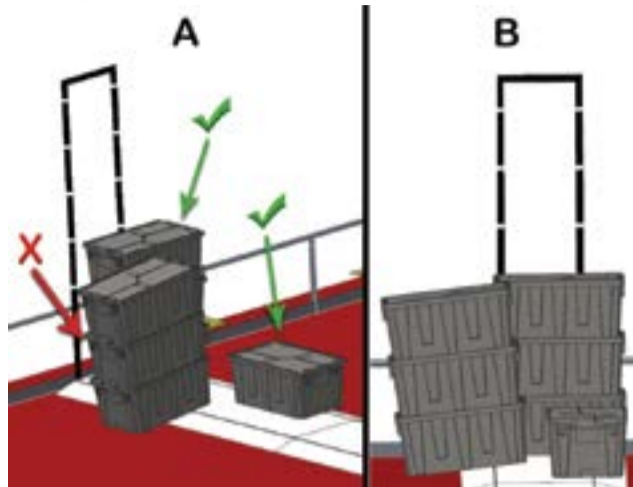
3.1.2.3 TELEOP

During TELEOP, points are awarded for scored TOTES, RECYCLING CONTAINERS, and LITTER.

TOTES

A Gray TOTE is scored if it is fully supported by a SCORING PLATFORM and no portion of the TOTE extends above the top of the BACKSTOP.

Figure 3-3: Scored Gray TOTE Example



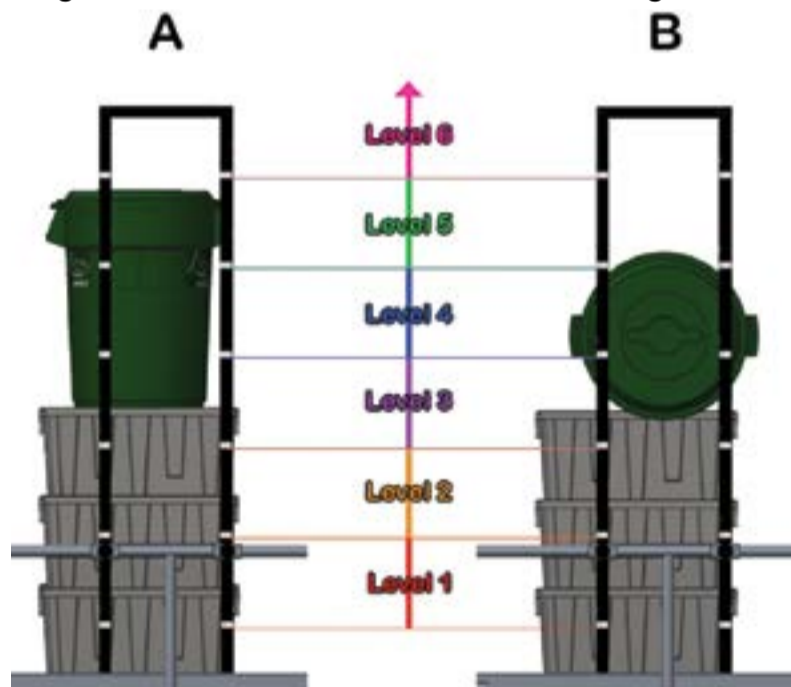
In Figure 3-3, two different perspectives are shown for a hypothetical scoring scenario at the end of an example MATCH. In this scenario, we have seven (7) TOTES that must be evaluated. The single TOTE, clearly visible on the lower right in Figure 3-3 Part A, is fully supported by the SCORING PLATFORM and is a scored Gray TOTE. The stack of TOTES closest to the BACKSTOP is also fully supported by the SCORING PLATFORM, and counts as three (3) scored Gray TOTES. The remaining stack of three (3) TOTES are not fully supported by the SCORING PLATFORM and do not score any points.

The design of the SCORING PLATFORM aids DRIVE TEAMS in determining when their TOTES are fully supported by the SCORING PLATFORMS. Generally, scored Gray TOTES would not be “leaning” off of either side, but rather they would be level with the top of the SCORING PLATFORM.

RECYCLING CONTAINERS

A RECYCLING CONTAINER is scored if it is fully supported by only scored Gray TOTES. Points for a scored RECYCLING CONTAINER are awarded based on the lowest LEVEL in which any portion of the RECYCLING CONTAINER resides. In Figure 3-4, colors have been added to indicate the LEVELS on the BACKSTOP. In both examples (A and B), the lowest part of the RECYCLING CONTAINER is in LEVEL 3.

Figure 3-4: RECYCLING CONTAINER scoring LEVELS



When REFEREES are assessing final scores at the end of the MATCH, if it is unclear whether a TOTE, RECYCLING CONTAINER, or LITTER (with the exception of LITTER in the LANDFILL ZONE) is being even partially supported by a ROBOT, the assumption will be that the ROBOT is supporting it (and thus it does not score). As such, it is highly recommend that DRIVE TEAMS make it very clear that their ROBOTS are not supporting any scored TOTES, RECYCLING CONTAINERS, or LITTER at the end of the MATCH.

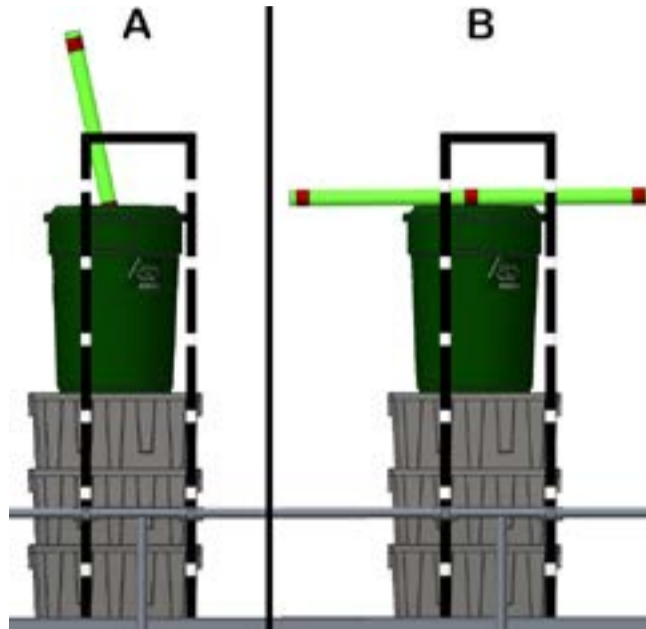
LITTER

Each LITTER can be scored in one (1) of three (3) ways:

- A. in or on a scored RECYCLING CONTAINER,
- B. in the Red or Blue LANDFILL ZONE, or
- C. as UNPROCESSED LITTER on either the Red or Blue side of the FIELD.

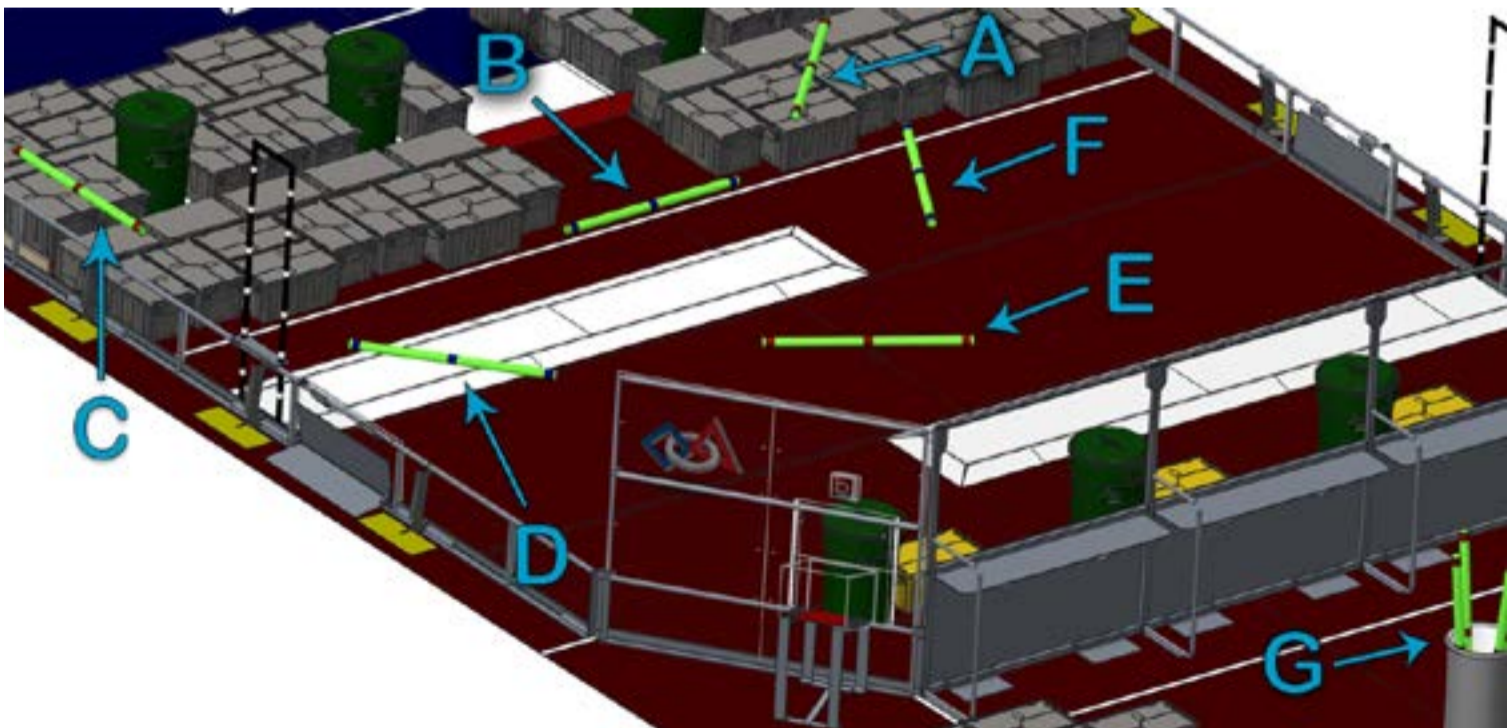
When a scored RECYCLING CONTAINER fully supports a LITTER, that LITTER is considered scored in or on that RECYCLING CONTAINER, as demonstrated in Figure 3-5 Parts A and B. A maximum of one (1) LITTER will be scored per RECYCLING CONTAINER.

Figure 3-5: LITTER in a scored RECYCLING CONTAINER



Additionally, LITTER is considered scored in a LANDFILL ZONE when it is fully contained within a LANDFILL ZONE, with each ALLIANCE credited for the LITTER scored in the LANDFILL ZONE on their side of the FIELD. For example, in Figure 3-6 LITTER A and B are fully contained within the Red LANDFILL ZONE, regardless of whether they're marked with Red or Blue and they are resting on top of TOTES. However, LITTER C is not entirely contained by the Red or Blue LANDFILL ZONE as it is hanging over onto the STEP and does not score. Litter D, E, F and G are not fully contained by the Red or Blue LANDFILL ZONE and do not score as LITTER in the LANDFILL.

Figure 3-6: LITTER within the ARENA at the end of a MATCH



Finally, ALLIANCES earn an UNPROCESSED LITTER Bonus for each LITTER that is fully contained by the opposite side of the FIELD, marked in their ALLIANCE'S color, and not scored in the LANDFILL ZONE or scored in a RECYCLING CONTAINER.

For example, in Figure 3-6 (above), LITTER C is not fully contained by the Red or Blue side of the FIELD and thus does not score as either LITTER in the LANDFILL or an UNPROCESSED LITTER Bonus for either ALLIANCE. LITTER D scores an UNPROCESSED LITTER Bonus for the Blue ALLIANCE because it is a Blue marked LITTER fully contained by the Red ALLIANCE side of the FIELD and not scored in the Red LANDFILL ZONE or a scored RECYCLING CONTAINER. LITTER E does not score an UNPROCESSED LITTER Bonus for the Blue ALLIANCE as it is not Blue marked LITTER. LITTER F scores an UNPROCESSED LITTER Bonus for the Blue ALLIANCE for the same reasons as LITTER D, even though it is partially within the Red LANDFILL ZONE. Finally, LITTER G remains in the Bin and does not score as an UNPROCESSED LITTER Bonus as it is not on the FIELD.

3.1.2.4 Point Values

Point values for the tasks in RECYCLE RUSH are detailed in Table 3-1 and Table 3-2.

Table 3-1: AUTO Point Values

Action	Value
ROBOT SET	4
TOTE SET	6
CONTAINER SET	8
STACKED TOTE SET	20

Table 3-2: TELEOP Point Values

Action	Value
Scored Gray TOTE	2 per TOTE
Scored RECYCLING CONTAINER	4 per LEVEL
LITTER Scored in/on a RECYCLING CONTAINER	6 per RECYCLING CONTAINER
LITTER Scored in a LANDFILL ZONE	1 per LITTER
UNPROCESSED LITTER Bonus	4 per LITTER
COOPERTITION SET*	20 for each ALLIANCE
COOPERTITION STACK*	40 for each ALLIANCE

**COOPERTITION SETS and COOPERTITION STACKS will not receive points during the Playoff MATCHES.*

As competition at the FIRST Championship is typically different from that during rest of the competition season, FIRST may alter each scoring value at the FIRST Championship.

AUTO scores are assessed when the ARENA timer displays zero (0) at the conclusion of AUTO. TELEOP scores, with the exception of Coopertition, are assessed based on the state of the FIELD when the ARENA timer displays zero (0), or, if not all elements have come to rest, five (5) seconds after the ARENA timer displays zero (0).

3.1.3 Penalty Assignment

Upon a rule violation, a FOUL will be issued and six (6) points will be decremented from the offending ALLIANCE'S score.

The minimum score for an ALLIANCE in a MATCH is zero (0).

3.1.4 MATCH Logistics

Game elements ejected from the FIELD will remain out of play for the remainder of the MATCH. Damaged ARENA or game elements will not be replaced until the next FIELD reset period. DRIVE TEAMS should be on the lookout for, and alert the FIELD staff to, any potentially damaged game elements prior to the start of the MATCH. There will not be an ARENA fault called for MATCHES that accidentally begin with damaged game elements.

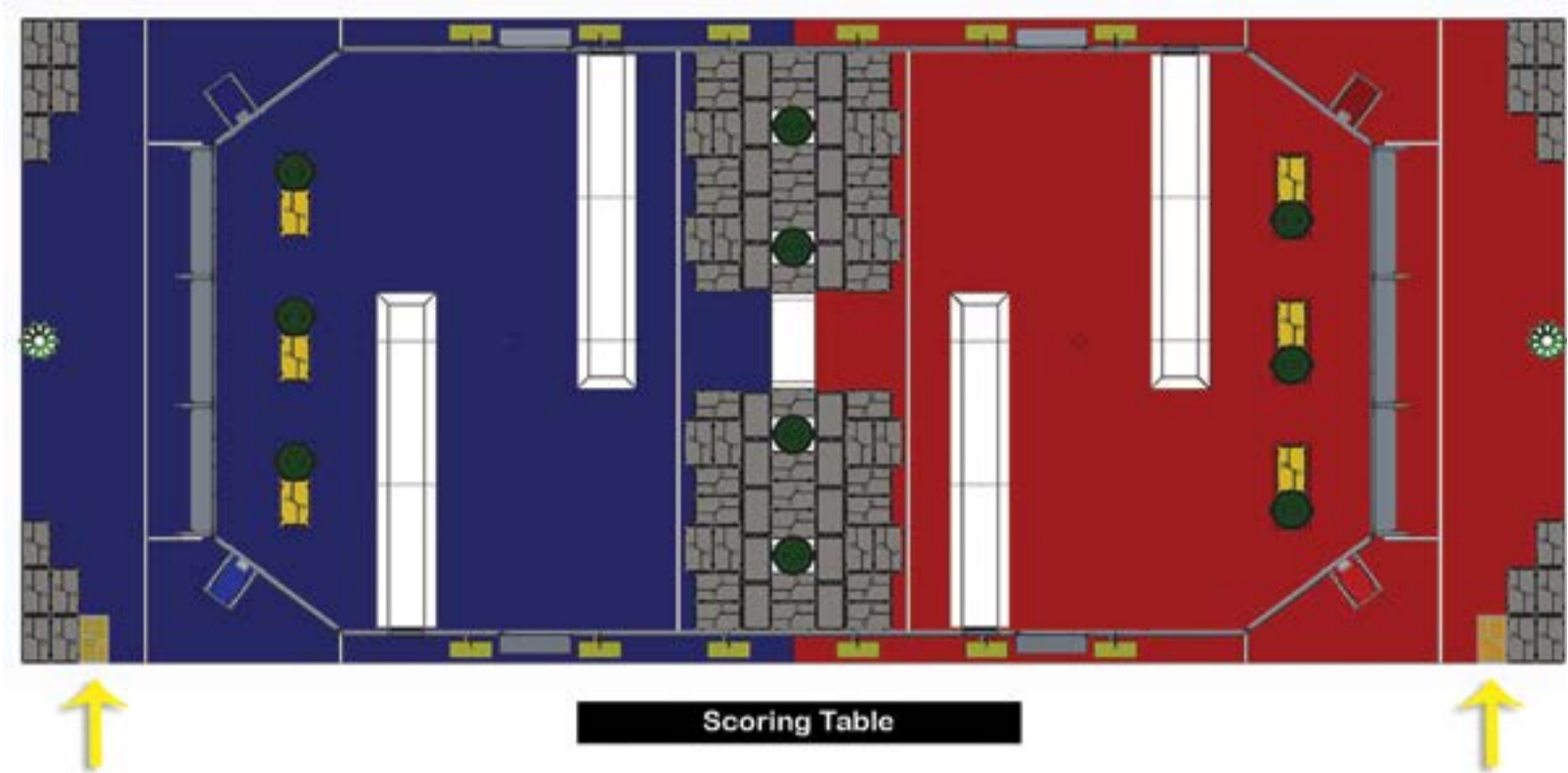
During the FIELD reset period, FIELD staff will return all TOTES, RECYCLING CONTAINERS and LITTER to their designated starting positions, where they must remain (with the exception of Yellow TOTES optionally being relocated to the designated area in the ALLIANCE STATION) until the start of the MATCH.

Section 3.1.4 is not intended to prohibit TEAMS, in coordination with FIELD Staff, from temporarily shifting the position of TOTES and RECYCLING CONTAINERS, if necessary, to get their ROBOTS in position for the start of the MATCH. However, the MATCH will not start until FIELD Staff have verified all TOTES and RECYCLING CONTAINERS are in their designated starting positions. TEAMS should keep in mind the requirements of G10 when getting their ROBOTS in position.

When a DRIVE TEAM loads their ROBOT onto the FIELD for a MATCH they may elect to remove the Yellow TOTE from the STAGING ZONE directly in front of their PLAYER STATION and instead place it in the ALLIANCE STATION, in the location indicated by the yellow arrows in Figure 3-7. However, if a DRIVE TEAM elects to leave their Yellow TOTE in the STAGING ZONE, they must leave it as positioned

by the FIELD staff. In the event that one or more ROBOTS does not report for a MATCH, its ALLIANCE may decide whether to leave their Yellow TOTE on the FIELD or place it in the designated starting position of the ALLIANCE STATION.

Figure 3-7: Alternate Yellow TOTE Starting Positions



DRIVE TEAMS may not move, nor preload TOTES (regardless of color), RECYCLING CONTAINERS, or LITTER onto their ROBOT prior to the start of the MATCH per G13. There are no rules that prohibit a ROBOT from being in contact with TOTES or RECYCLING CONTAINERS at the start of the MATCH, as long as those items were not moved from their STAGING ZONE as described in the paragraph above.

3.2 Game Rules

The rules in this section legislate game play and define the consequences for rule violations as enforced by the REFEREES.

3.2.1 Safety

G1 ROBOTS whose operation or design is dangerous or unsafe are not permitted.

VIOLATION: If before the MATCH, the offending ROBOT will not be allowed to participate in the MATCH. If during the MATCH, the offending ROBOT will be DISABLED.

Examples include, but are not limited to:

- A. Uncontrolled motion that cannot be stopped by the DRIVE TEAM
- B. ROBOTS arms “flailing” off the FIELD
- C. ROBOTS dragging their battery
- D. ROBOTS that consistently extend outside the FIELD

G2 DRIVE TEAMS may only enter the FIELD if the PLAYER STATION LED strings are green, unless explicitly instructed by FIELD staff.

VIOLATION: YELLOW CARD

G3 DRIVE TEAMS may not climb over or step on game elements or the STEP. DRIVE TEAMS may only enter or exit the FIELD through open gates.

VIOLATION: If egregious or repeated, YELLOW CARD

G4 DRIVE TEAMS may not extend any body part into the FIELD during the MATCH.

VIOLATION: FOUL. If egregious or repeated, RED CARD

Examples of egregious violations include, but are not limited to, walking onto the FIELD during a MATCH or intentionally reaching into the FIELD and grabbing a TOTE or ROBOT during a MATCH.

- G5** Only one ALLIANCE member may be in each HUMAN PLAYER ZONE (i.e. touching the carpet in a HUMAN PLAYER ZONE), in contact with elements of that HUMAN PLAYER STATION (i.e. elements depicted in Figure 2-12), or in the HUMAN PLAYER ZONE and in contact with the the elements of that HUMAN PLAYER STATION, at a time.

VIOLATION: *FOUL. Additional FOUL for each TOTE entered onto the FIELD while in violation of this rule.*

The intent of G5 is to ensure that one ALLIANCE member does not work the elements of the HUMAN PLAYER STATION while another ALLIANCE member feeds TOTES or LITTER into their respective CHUTES. TOTES, even if in the HUMAN PLAYER ZONE, are not elements of the HUMAN PLAYER STATION, and therefore not affected by G5 (i.e. two people can be in contact with the same TOTE simultaneously).

- G6** A single ALLIANCE member may not be in contact with both a TOTE and the CHUTE DOOR simultaneously, directly or through the use of any object (except for via normal operation of the CHUTE or CHUTE DOOR).

VIOLATION: *FOUL.*

For details on the operation of the CHUTE DOOR, please watch the Field Tour videos on the [FRC YouTube channel](#).

- G6-1** DRIVE TEAMS may not use any object to prop the CHUTE DOOR open.

VIOLATION: *FOUL and YELLOW CARD. If egregious or repeated, RED CARD.*

- G6-2** The CHUTE DOOR may only be operated by a DRIVER or HUMAN PLAYER.

VIOLATION: *RED CARD.*

3.2.2 Pre-MATCH and Post-MATCH

- G7** When placed on the FIELD for a MATCH, each ROBOT must be:

- A. in compliance with all ROBOT rules, i.e. it has passed Inspection. For exceptions regarding Practice MATCHES, see [Section 5.2 – Practice MATCHES](#).
- B. fully supported by the floor, SCORING PLATFORM, and/or SCORING PLATFORM ramps on their ALLIANCE'S side of the FIELD, and
- C. completely outside of their AUTO ZONE and LANDFILL ZONE.

VIOLATION: *If fix is a quick remedy, the MATCH won't start until all requirements are met. If it is not a quick remedy the offending ROBOT will be DISABLED and at the discretion of the Head REFEREE must be re-Inspected.*

If a ROBOT is DISABLED prior to the start of the MATCH, the DRIVE TEAM may not remove the ROBOT from the FIELD without the permission of the Head REFEREE.

- G8** DRIVE TEAMS may not leave items other than their ROBOT on the FIELD.

VIOLATION: *The MATCH will not start until the situation is corrected*

- G9** DRIVE TEAMS may only bring hand tools, including battery-operated hand tools, onto the FIELD to configure or disassemble their ROBOTS.

VIOLATION: *At the discretion of the Head REFEREE, the DRIVE TEAM will be reminded of the requirements of this rule. However, if egregious or repeated, YELLOW CARD.*

- G10** DRIVE TEAMS may not cause significant or repeated delays to the start of a MATCH.

VIOLATION: *The offending ROBOT will be DISABLED*

DRIVE TEAMS are expected to stage their ROBOTS for a MATCH safely and swiftly. As a guideline, ROBOTS should be configurable in fewer than sixty (60) seconds. DRIVE TEAM efforts that either intentionally or unintentionally delay the start of a MATCH are not allowed. Examples of such delays include, but are not limited to:

- A. prolonged use of alignment devices such as templates, tape measures, laser pointers, etc. to precisely place and/or align the ROBOT
- B. late arrival to the FIELD
- C. being indecisive about where/how to position a ROBOT or Yellow TOTE
- D. failing to exit the FIELD once the green lights in the ALLIANCE STATIONS have turned off (indicating MATCH ready)
- E. charging pneumatic systems, or any other ROBOT maintenance, once on the FIELD
- F. prolonged assembly/disassembly of a ROBOT to transform it from its TRANSPORT CONFIGURATION

G11 DRIVE TEAMS may not cause significant or repeated delays to FIELD reset at the conclusion of the MATCH.

VIOLATION: *YELLOW CARD*

DRIVE TEAMS are expected to remove ROBOTS from the FIELD after the MATCH safely and swiftly. As a guideline, ROBOTS should be configurable in fewer than sixty (60) seconds. DRIVE TEAM efforts that either intentionally or unintentionally delay the FIELD reset process are not allowed. Examples of such delays include, but are not limited to:

- A. prolonged assembly/disassembly of a ROBOT to transform it to its TRANSPORT CONFIGURATION
- B. taking an excessive amount of time to exit the field after a MATCH is complete

G12 DRIVE TEAMS must be in the ALLIANCE STATION and behind the STARTING LINE prior to the start of the MATCH.

VIOLATION: *MATCH will not start until the situation is corrected*

G13 DRIVE TEAMS may not rearrange TOTES or LITTER prior to the start of the MATCH, with the exception of Yellow TOTE placement per [Section 3.1.4: MATCH Logistics](#).

VIOLATION: *MATCH will not start until the situation is corrected*

G14 ROBOTS will not be re-enabled after the conclusion of the MATCH, nor will Teams be permitted to tether to the ROBOT except in exceptional circumstances (e.g. during TIMEOUTS, after Opening Ceremonies, etc.) and with express permission from the FTA or a Referee.

VIOLATION: *RED CARD*

Tethering includes any wired connection used to electrically energize and/or control elements on the ROBOT.

3.2.3 General Rules

G15 All Teams must be civil towards their own Team members, other Teams, competition personnel, FIELD staff, and event attendees while at an FRC event.

VIOLATION: *Behavior will be discussed with Team or individual. If egregious or repeated, YELLOW or RED CARD.*

Examples of incivility include, but are not limited to, use of offensive language or bullying behavior.

G16 The following actions are prohibited with regards to interaction with FIELD elements (items A-D exclude TOTES, RECYCLING CONTAINERS, and LITTER):

- A. grabbing
- B. grasping
- C. grappling
- D. attaching to
- E. becoming entangled
- F. hanging from
- G. damaging (exception: unintentional damage to LITTER)
- H. tying
- I. removing or repositioning LITTER tape

VIOLATION: *FOUL. If the Head REFEREE determines that further damage is likely to occur, offending ROBOT will be DISABLED. Corrective action (such as eliminating sharp edges, removing the damaging MECHANISM, and/or re-Inspection) may be required before the ROBOT will be allowed to compete in subsequent MATCHES.*

Driving over LITTER leading to LITTER damage is not a violation of this rule, provided that, in the judgement of the Referee, the LITTER damage was not the objective of the action.

Examples of prohibited interaction with FIELD elements include:

- A. use of hook-and-loop fastener to attach a ROBOT to the carpet
- B. humans or ROBOTS tying or weaving LITTER into a knot
- C. a strategy involving the removal of cable ties from TOTES or RECYCLING CONTAINERS

G17 ROBOTS may not push or react against the white horizontal surface of the STEP. Incidental reaction while interacting with TOTES or RECYCLING CONTAINERS is an exception to this rule.

VIOLATION: *FOUL. If repeated, offending ROBOT will be DISABLED.*

G18 ROBOTS may not contact any portion of an object where that portion is beyond the STEP. Momentary contact as a result of ROBOT to ROBOT interaction, direct or indirect (e.g. via a RECYCLING CONTAINER), over the STEP is an exception to this rule. If a ROBOT becomes inoperable or “stuck” while some portion of the ROBOT is extending beyond the STEP, the ROBOT will not receive multiple FOULS.

VIOLATION: *FOUL. If egregious or strategic, RED CARD.*

Figure 3-8: Extension beyond the STEP Examples



In Figure 3-8 ROBOT A is not in violation of G18 because its MECHANISM is entirely within the STEP, which is a shared zone for both ALLIANCES. For ROBOT B, there is also no violation because, even though it has extended onto the Blue ALLIANCE side of the FIELD, the ROBOT is not contacting anything on that side. ROBOT C is in contact with Blue ROBOT D over the STEP which results in no violation as the STEP is a shared zone. ROBOT E has extended from the Blue onto the Red side of the FIELD and contacted a TOTE, which results in a violation of G18. ROBOT F is in contact with a portion of the TOTE that is not beyond the STEP, which results in no violation. ROBOT G is in contact with a portion of a TOTE that is beyond the STEP, which results in a violation of G18.

3.2.4 AUTO Rules

G19 During AUTO, DRIVE TEAMS must remain behind the STARTING LINE and may not contact the OPERATOR CONSOLE, unless for personal or equipment safety.

VIOLATION: *FOUL. If contact with the OPERATOR CONSOLE, YELLOW CARD.*

G20 During AUTO, any control devices worn or held by the DRIVERS and/or HUMAN PLAYERS must be disconnected from the OPERATOR CONSOLE.

VIOLATION: *FOUL*

G21 During AUTO, DRIVE TEAMS must not directly or indirectly interact with ROBOTS or OPERATOR CONSOLES.

VIOLATION: *FOUL and YELLOW CARD*

FIRST salutes the creative and innovative ways in which Teams have interacted with their ROBOTS during AUTO in previous seasons, making the AUTO period more of a hybrid period due to indirect interaction with the OPERATOR CONSOLE. The RECYCLE RUSH AUTO Period, however, is meant to be truly autonomous and ROBOT or OPERATOR CONSOLE interaction (such as through webcam or Kinect™) are prohibited.

3.2.5 ROBOT Actions

G22 ROBOT height must not exceed 6 ft. 6 in. during the MATCH.

VIOLATION: *FOUL. If strategic, offending ROBOT will be DISABLED.*

For reference, the height restriction matches the height of the ALLIANCE WALL. However, it is expected that ROBOTS that are on a SCORING PLATFORM may actually be slightly taller than the ALLIANCE WALL due to the elevation of the SCORING PLATFORM. This is permitted and not a violation of G22.

An example of a strategic violation of G22 would be intentionally extending above the height restriction in an effort to complete a scoring action.

G23 ROBOTS may not cause TOTES, RECYCLING CONTAINERS, and/or LITTER to completely leave the FIELD.

VIOLATION: *FOUL for each item. If egregious, offending ROBOT will be DISABLED.*

G24 ROBOTS may not cause TOTES, RECYCLING CONTAINERS, and/or LITTER to completely transfer from their side of the FIELD, or from the STEP, onto the opposite side of the FIELD.

VIOLATION: *FOUL for each item. If egregious or strategic, RED CARD and offending ROBOT will be DISABLED.*

G25 ROBOTS may not intentionally detach or leave parts on the FIELD.

VIOLATION: *RED CARD*

G25 is not intended to penalize ROBOTS that encounter accidental breakage (e.g. a failed MECHANISM that falls off), as those actions are not intentional.

G26 Strategies aimed at the destruction or inhibition of ROBOTS via attachment, damage, tipping, or entanglements are not allowed.

VIOLATION: *FOUL and YELLOW CARD. If egregious, RED CARD.*

G27 ROBOTS and anything they control (except for LITTER in the LITTER CHUTE and TOTES in the TOTE CHUTE), may not contact anything outside the FIELD.

VIOLATION: *Offending ROBOT will be DISABLED.*

Please be conscious of REFEREES and FIELD staff working around the ARENA who may be in close proximity to your ROBOT.

3.2.6 Human Actions

G28 DRIVE TEAMS must wear their designated buttons in a clearly visible location at all times while in the ARENA. During a Playoff MATCH, the ALLIANCE CAPTAIN must clearly display the designated ALLIANCE CAPTAIN identifier (e.g. hat or armband).

VIOLATION: *MATCH will not start until the situation is corrected. Those not displaying identification will be asked to leave the ARENA.*

G29 Only the DRIVE TEAMS for the current MATCH are allowed in their respective ALLIANCE STATIONS.

VIOLATION: *MATCH will not start until the situation is corrected. Those not displaying identification will be asked to leave the ARENA.*

G30 DRIVE TEAM members must remain fully within the ALLIANCE STATION for the duration of the MATCH, unless for personal safety.

VIOLATION: *FOUL. If strategic, RED CARD for the entire ALLIANCE.*

An example of a strategic violation of this rule is taking a FOUL for a net points gain, such as leaving the ALLIANCE STATION to introduce Yellow TOTES into the AUTO ZONE.

G31 COACHES may not touch TOTES or LITTER, unless for personal safety.

VIOLATION: *FOUL*

G32 During a MATCH, the ROBOT shall be operated solely by the DRIVERS and/or HUMAN PLAYERS of that Team.

VIOLATION: *Offending ROBOT will be DISABLED.*

Exceptions may be made before a MATCH for major conflicts, e.g. religious holidays, major testing, transportation issues, etc.

G33 LITTER may be introduced onto the FIELD only during TELEOP and only in the following ways:

- A. through the LITTER CHUTE, or
- B. over the ALLIANCE WALL prior to the last twenty (20) seconds of the MATCH.

VIOLATION: *FOUL per LITTER.*

G34 TOTES may only be introduced to the FIELD through the TOTE CHUTE.

VIOLATION: *FOUL per TOTE.*

4

The Robot

4.0	The Robot	28
4.1	Overview	29
4.2	General ROBOT Design	30
4.3	Safety & Damage Prevention	31
4.4	Budget Constraints	32
4.5	Fabrication Schedule	33
4.6	Material Utilization	35
4.7	Motors & Actuators	36
4.8	Power Distribution	37
4.9	Control, Command & Signals System	42
4.10	Pneumatic System	45
4.11	OPERATOR CONSOLE	48

FIRST®, the FIRST® logo, FIRST® Robotics Competition, FRC®, FIRST® Tech Challenge, Coopertition®, Gracious Professionalism®, and RECYCLE RUSHSM are trademarks of the United States Foundation for Inspiration and Recognition of Science and Technology (FIRST®). FIRST® LEGO® League is a jointly held trademark of FIRST and the LEGO Group. LEGO® is a registered trademark of the LEGO Group. © 2015 FIRST. All rights reserved.

4 THE ROBOT

This section of the *2015 FRC Game Manual* presents legislation relevant to the construction of a 2015 *FIRST* Robotics Competition (FRC) ROBOT. ROBOTS will be Inspected at each FRC event to confirm compliance before being allowed to compete, per [Section 5.5.2: Eligibility and Inspection](#).

4.1 Overview

The rules listed below explicitly address what and how parts and materials may be used on a 2015 FRC ROBOT. There are many reasons for the structure of the rules, including safety, reliability, parity, creation of a reasonable design challenge, adherence to professional standards, impact on the competition, compatibility with the Kit of Parts (KOP), which is the collection of items listed on any *Kickoff Kit Checklist*, distributed via *FIRST* Choice, or obtained via a Product Donation Voucher (PDV), etc.

Another intent of these rules is to have all energy sources and active actuation systems on the ROBOT (e.g. batteries, compressors, motors, servos, cylinders, and their controllers) drawn from a well-defined set of options. This is to ensure that all Teams have access to the same actuation resources and that the Inspectors are able to accurately assess the legality of a given part.

Many rules in this section reference Commercial-Off-The-Shelf (COTS) items. A COTS item must be a standard (i.e. not custom order) part commonly available from a VENDOR for all Teams for purchase. To be a COTS item, the COMPONENT or MECHANISM must be in an unaltered, unmodified state. Items that are no longer commercially available but are functionally equivalent to the original condition as delivered from the VENDOR are considered COTS and may be used.

EXAMPLE 1: A Team orders two (2) ROBOT grippers from RoboHands Corp. and receives both items. They put one in their storeroom and plan to use it later. Into the other, they drill “lightening holes” to reduce weight. The first gripper is still classified as a COTS item, but the second gripper is now a FABRICATED ITEM, as it has been modified.

EXAMPLE 2: A Team obtains openly available blueprints of a drive module commonly available from Wheels-R-Us Inc. and has local machine shop “We-Make-It, Inc.” manufacture a copy of the part for them. The produced part is NOT a COTS item, because it is not commonly carried as part of the standard stock of We-Make-It, Inc.

EXAMPLE 3: A Team obtains openly available design drawings from a professional publication during the pre-season, and uses them to fabricate a gearbox for their ROBOT during the build period following Kickoff. The design drawings are considered a COTS item, and may be used as “raw material” to fabricate the gearbox. The finished gearbox itself would be a FABRICATED ITEM, and not a COTS item.

EXAMPLE 4: A COTS part that has non-functional label markings added is still considered a COTS part, but a COTS part that has device-specific mounting holes added is a FABRICATED ITEM.

EXAMPLE 5: A team has a COTS single-board processor version 1.0, which can no longer be purchased. Only the COTS single-board processor version 2.0 may be purchased. If the COTS single-board processor version 1.0 is functionally equivalent to its original condition, it may be used.

EXAMPLE 6: A team has a COTS gearbox which has been discontinued. If the COTS gearbox is functionally equivalent to its original condition, it may be used.

Generally available software modules obtained from open sources (e.g. professional publications, commonly used FRC community-accessible web resources, industry source code repositories, etc.) that are not specifically affiliated with individual FRC Teams are considered COTS items.

A VENDOR is a legitimate business source for COTS items that satisfies all of the following criteria:

- A. has a Federal Tax Identification number. In cases where the VENDOR is outside of the United States, they must possess an equivalent form of registration or license with the government of their home nation that establishes and validates their status as a legitimate business licensed to operate within that country.
- B. is not a “wholly owned subsidiary” of an FRC Team or collection of FRC Teams. While there may be some individuals affiliated with both an FRC Team and the VENDOR, the business and activities of the Team and VENDOR must be completely separable.
- C. must be able to ship any general (i.e., non-*FIRST* unique) product within five business days of receiving a valid purchase request. It is recognized that certain unusual circumstances (such as 1,000 *FIRST* Teams all ordering the same part at once from the same VENDOR) may cause atypical delays in shipping due to backorders for even the largest VENDORS. Such delays due to higher-than-normal order rates are excused.
- D. should maintain sufficient stock or production capability to fill Teams’ orders within a reasonable period during the season (less than 1 week). (Note that this criterion may not apply to custom-built items from a source that is both a VENDOR and a fabricator. For example, a VENDOR may sell flexible belting that the Team wishes to procure to use as treads on their drive system. The VENDOR cuts the belting to a custom length from standard shelf stock that is typically available, welds it into a loop to make a tread, and ships it to a

Team. The fabrication of the tread takes the VENDOR two weeks. This would be considered a FABRICATED ITEM, and the two weeks ship time is acceptable.) Alternately, the Team may decide to fabricate the treads themselves. To satisfy this criterion, the VENDOR would just have to ship a length of belting from shelf stock (i.e. a COTS item) to the Team within five business days and leave the welding of the cuts to the Team.)

- E. makes their products available to all FRC Teams. VENDOR must not limit supply or make a product available to just a limited number of FRC Teams.

The intent of this definition is to be as inclusive as possible to permit access to all legitimate sources, while preventing ad hoc organizations from providing special-purpose products to a limited subset of Teams in an attempt to circumvent the cost accounting rules.

FIRST desires to permit Teams to have the broadest choice of legitimate sources possible, and to obtain COTS items from the sources that provide them with the best prices and level of service available. Teams also need to protect against long delays in availability of parts that will impact their ability to complete their ROBOT. The FRC build season is brief, so the VENDOR must be able to get their product, particularly *FIRST* unique items, to a Team in a timely manner.

Ideally, chosen VENDORS should have national distributors (e.g. Home Depot, Lowes, MSC, Radio Shack, McMaster-Carr, etc.). Remember, FRC events are not always near home – when parts fail, local access to replacement materials is often critical.

Teams may be asked to provide documentation proving legality of non-2015 KOP items during Inspection where a Rule specifies limits for a legal part (e.g. pneumatic items, current limits, COTS electronics, etc.).

Some of these rules make use of English unit requirements for parts. If your team has a question about a metric-equivalent part's legality, please e-mail your question to frcparts@usfirst.org for an official ruling. To seek approval for alternate devices for inclusion in future FRC seasons, please contact frcparts@usfirst.org with item specifications.

Teams should acknowledge the support provided by the corporate Sponsors and Mentors with an appropriate display of their school and Sponsors names and/or logos (or the name of the supporting youth organization, if appropriate).

FRC can be a full-contact ROBOT competition and may include rigorous game play. While Game and ROBOT Rules limit severe damage to ROBOTS, Teams should design their ROBOTS to be robust.

Veteran teams will notice that this Manual does not contain rules for bumpers. Bumpers for Recycle Rush robots are optional. Teams, however, should give serious consideration as to whether or not they would like to add bumpers to their robots to provide protection from impact. Suggested bumper designs can be [found here](#).

Bumpers, if present, are considered part of the robot, and are included as part of the robot size constraints per R3 and weight limit per R4. This also means that bumpers are not exempt from Fabrication Schedule requirements per [Section 4.5: Fabrication Schedule](#).

Bumpers, if present, do not need to change color to match Alliance color. This means a single set of bumpers may stay affixed to the robot throughout the event, if the team desires.

4.2 General ROBOT Design

- R1** A Team must submit their ROBOT for Inspection. The ROBOT must be built by the FRC Team to perform specific tasks when competing in RECYCLE RUSH. The ROBOT must include all of the basic systems required to be an active participant in the game – power, communications, control, and movement. The ROBOT implementation must obviously follow a design approach intended to play RECYCLE RUSHSM (e.g. a box of unassembled parts placed on the FIELD, or a ROBOT designed to play a different game does not satisfy this definition).

R1 requires that the ROBOT a Team uses in competition was built by that Team, but isn't intended to prohibit assistance from other Teams (e.g. fabricating elements, supporting construction, writing software, developing game strategy, contributing COMPONENTS and/or MECHANISMS, etc.).

- R2** Team numbers must be displayed on the ROBOT and meet the following criteria:

- A. consist of numerals at least 3.5 in. high, at least 0.5 in. in stroke width, and be black in color with a white background extending at least 1 in. from the edges of the numbering,

Figure 4-1: Team number display



- B. be positioned around the ROBOT such that an observer walking around the perimeter of the ROBOT can unambiguously tell the Team's number from any point of view.

The intent is that the Team's number is clearly visible and unambiguous so that Judges, Referees, Announcers, and other Teams can easily identify competing ROBOTS. Consider the numbers as the license plates for your ROBOT. If an observer has to follow a tether to identify the ROBOT's team number, that is considered not clearly visible and does not meet the requirements of R2.

Note: Impact font, size 362pt., shown in Figure 4-1, meets the stroke and height requirements for all digits.

R3 The ROBOT must satisfy the following size constraints:

- A. during a MATCH, the ROBOT height may not exceed 78 in.
- B. the ROBOT must be able to be arranged into a TRANSPORT CONFIGURATION with dimensions which do not exceed 28 in. wide, 42 in. long, and 78 in. tall.

Size constraints specified in part A may be met with either hardware or software.

Size constraints specified in part B may be met with additional aids such as bungee cords, minor disassembly, etc., provided transition from/to the TRANSPORT CONFIGURATION does not risk violation of other rules, particularly G10 and G11.

Teams should think carefully about how they will transfer their ROBOTS from place to place during the events. Many FIRST Robotics Competitions take place in venues with standard sized doors. Be sure to consider the size of the ROBOT on its cart to make sure it will fit through doors. Also consider the size of the ROBOT to ensure that it will fit into a shipping crate, bag, vehicle, etc.

FRC event scales are 36 in. x 36 in. square. If your ROBOT cannot be self-supporting on a 36 in. x 36 in. square, ensure you have a way of supporting the ROBOT on the 36 in. x 36 in. scale.

R4 The ROBOT weight may not exceed 120 lbs. When determining weight, the basic ROBOT structure and all elements of all additional MECHANISMS that might be used in different configurations of the ROBOT shall be weighed together.

Unlike in recent FRC seasons, this 120 lb weight limit includes any optional bumpers on the ROBOT.

For the purposes of determining compliance with the weight limitations, the ROBOT battery and its associated half of the Anderson cable quick connect/disconnect pair (including no more than 12 in. of cable per leg, the associated cable lugs, connecting bolts, and insulation) are excluded.

R5 Traction devices may not have surface features such as metal, sandpaper, hard plastic studs, cleats, hook-loop fasteners or similar attachments. Traction devices include all parts of the ROBOT that are designed to transmit any propulsive and/or braking forces between the ROBOT and FIELD carpet.

R6 ROBOTS must allow removal of LITTER, RECYCLING CONTAINERS, and TOTES from the ROBOT and the ROBOT from FIELD elements while DISABLED and powered off.

ROBOTS will not be re-enabled after the MATCH, so Teams must be sure that LITTER, RECYCLING CONTAINERS, TOTES and ROBOTS can be quickly, simply, and safely removed.

4.3 Safety & Damage Prevention

R7 Protrusions from the ROBOT and exposed surfaces on the ROBOT shall not pose hazards to the ARENA elements (including the LITTER, RECYCLING CONTAINERS and TOTES) or people.

If the ROBOT includes protrusions that form the "leading edge" of the ROBOT as it drives and have a surface area of less than 1 in.², it will invite detailed inspection. For example, forklifts, lifting arms, or grapples may be carefully inspected for these hazards.

- R8** ROBOT parts shall not be made from hazardous materials, be unsafe, cause an unsafe condition, or interfere with the operation of other ROBOTS.

Examples of items that will violate R8 include (but are not limited to):

- A. Shields, curtains, or any other devices or materials designed or used to obstruct or limit the vision of any DRIVERS and/or COACHES and/or interfere with their ability to safely control their ROBOT
 - B. Speakers, sirens, air horns, or other audio devices that generate sound at a level sufficient to be a distraction
 - C. Any devices or decorations specifically intended to jam or interfere with the remote sensing capabilities of another ROBOT, including vision systems, acoustic range finders, sonars, infrared proximity detectors, etc. (e.g. including imagery on your ROBOT that, to a reasonably astute observer, mimics the Vision Guides)
 - D. Exposed lasers other than Class I.
 - E. Flammable gasses
 - F. Any device intended to produce flames or pyrotechnics
 - G. Hydraulic fluids or hydraulic items
 - H. Switches or contacts containing liquid mercury
 - I. Circuitry used to create voltages in excess of 24V
 - J. Any ballast not secured sufficiently, including loose ballast e.g. sand, ball bearings, etc., such that it may become loose during a MATCH.
- Teams should provide MSD Sheets for any materials they use that might be considered questionable during ROBOT Inspection.

4.4 Budget Constraints

- R9** The total cost of all items on the ROBOT shall not exceed \$4000 USD. All costs are to be determined as explained in [Section 4.4: Budget Constraints](#). Exceptions are as follows:

- A. individual COTS items that are less than \$1 USD each and
- B. KOP items

Teams should be prepared to disclose to Inspectors the cost of any non-KOP item and the total cost of the ROBOT.

There is no quantity limit on KOP items in regards to R9. If the item is a KOP item, it does not require an associated cost on the BOM.

Per T11, Teams must be prepared to display a Bill of Materials (BOM) to Inspectors during Inspection. The BOM may be displayed in either printed or electronic form.

Individual COMPONENTS or MECHANISMS, not excluded in R9, that are retrieved from previous ROBOTS and used on 2015 ROBOTS must have their undepreciated cost included in the 2015 BOM and applied to the overall cost assessment.

- R10** No individual, non-KOP item shall have a value that exceeds \$400 USD. The total cost of COMPONENTS purchased in bulk may exceed \$400 USD as long as the cost of an individual COMPONENT does not exceed \$400 USD.

If a COTS item is part of a modular system that can be assembled in several possible configurations, then each individual module must fit within the price constraints defined in R10.

If the modules are designed to assemble into a single configuration, and the assembly is functional in only that configuration, then the total cost of the complete assembly including all modules must fit within the price constraints defined in R10.

In summary, if a VENDOR sells a system or a kit, a team must use the entire system/kit Fair Market Value and not the value of its COMPONENT pieces.

EXAMPLE 1: VENDOR A sells a gearbox that can be used with a number of different gear sets, and can mate with two different motors they sell. A team purchases the gearbox, a gear set, and a motor (which are not offered together as an assembly or kit), then assembles them together. Each part is treated separately for the purpose of BOM costing, since the purchased pieces can each be used in various configurations.

EXAMPLE 2: VENDOR B sells a robotic arm assembly that the team wants to use. However, it costs \$700 USD, so they cannot use it. The VENDOR sells the "hand", "wrist", and "arm" as separate assemblies, for \$200 USD each. A team wishes to purchase the three items separately, then reassemble them. This would not be legal, as they are really buying and using the entire assembly, which has a Fair Market Value of \$700 USD.

EXAMPLE 3: VENDOR C sells a set of wheels or wheel modules that are often used in groups of four. The wheels or modules can be used in other quantities or configurations. A team purchases four and uses them in the most common configuration. Each part is treated separately for the purpose of BOM costing, since the purchased pieces can be used in various configurations.

R11 The BOM cost of each non-KOP item must be calculated based on the unit fair market value for the material and/or labor, except for labor provided by Team members (including sponsor employees who are members of the team), members of other Teams, event provided Machine Shops and shipping.

EXAMPLE 1: A Team orders a custom bracket made by a company to the Team's specification. The company's material cost and normally charged labor rate apply.

EXAMPLE 2: A Team receives a donated sensor. The company would normally sell this item for \$52 USD, which is therefore its fair market value.

EXAMPLE 3: Special price discounts from National Instruments and other FRC Suppliers are being offered to all FIRST Teams. The discounted purchase price of items from these sources may be used in the additional parts accounting calculations.

EXAMPLE 4: A Team purchases steel bar stock for \$10 USD and has it machined by a local machine shop. The machine shop is not considered a team Sponsor, but donates two (2) hours of expended labor anyway. The Team must include the estimated normal cost of the labor as if it were paid to the machine shop, and add it to the \$10 USD.

EXAMPLE 5: A Team purchases steel bar stock for \$10 USD and has it machined by a local machine shop that is a recognized Sponsor of the Team. If the machinists are considered members of the Team, their labor costs do not apply. The total applicable cost for the part would be \$10 USD.

It is in the best interests of the Teams and FIRST to form relationships with as many organizations as possible. Teams are encouraged to be expansive in recruiting and including organizations in their team, as that exposes more people and organizations to FIRST. Recognizing supporting companies as Sponsors of, and members in, the Team is encouraged, even if the involvement of the Sponsor is solely through the donation of fabrication labor.

EXAMPLE 6: A Team purchases steel bar stock for \$10 USD and has it machined by another Team. The total applicable cost for the part would be \$10 USD.

EXAMPLE 7: A Team purchases a 4 by 4 ft sheet of aluminum, but only uses a piece 10 by 10 in. on their ROBOT. The Team identifies a source that sells aluminum sheet in 1 by 1 ft pieces. The Team may cost their part on the basis of a 1 by 1 ft piece, even though they cut the piece from a larger bulk purchase. They do not have to account for the entire 4 by 4 ft bulk purchase item.

4.5 Fabrication Schedule

R12 Physical ROBOT elements created before Kickoff are not permitted. Exceptions are:

- A. OPERATOR CONSOLE,
- B. battery assemblies per R4,
- C. FABRICATED items consisting of one COTS electrical device (e.g. a motor or motor controller), connectors, and any materials used to secure and insulate those connectors

Please note that this means that FABRICATED ITEMS from ROBOTS entered in previous FIRST competitions may not be used on ROBOTS in the 2015 FRC (other than those allowed per R12-C). Before the formal start of the FRC Build Season, Teams are encouraged to think as much as they please about their ROBOTS. They may develop prototypes, create proof-of-concept models, and conduct design exercises. Teams may gather all the raw stock materials and COTS COMPONENTS they want.

EXAMPLE 1: A Team designs and builds a two-speed shifting transmission during the fall as a training exercise. After Kickoff, they utilize all the design principles they learned in the fall to design their ROBOT. To optimize the transmission design for their ROBOT, they improve the transmission gear ratios and reduce the size, and build two new transmissions, and place them on the ROBOT. All parts of this process are permitted activities.

EXAMPLE 2: A Team re-uses a 2015-legal motor from a previous Robot which has had connectors added to the wires. This is permitted, per exception C, because the motor is a COTS electrical COMPONENT.

- R13** Software and mechanical/electrical designs created before Kickoff are only permitted if the source files (complete information sufficient to produce the design) are available publicly prior to Kickoff.

EXAMPLE 1: A Team realizes that the transmission designed and built in the fall perfectly fits their need for a transmission to drive the ROBOT arm. They build an exact copy of the transmission from the original design plans, and bolt it to the ROBOT. This would be prohibited, as the transmission – although made during the competition season – was built from detailed designs developed prior to Kickoff.

EXAMPLE 2: A Team developed an omni-directional drive system for the 2011 competition. Over the summer of 2011 they refined and improved the control software (written in C) to add more precision and capabilities. They decided to use a similar system for the 2015 competition. They copied large sections of unmodified code over into the control software of the new ROBOT (also written in C). This would be a violation of the schedule constraint, and would not be allowed.

EXAMPLE 3: The same Team decides to use LabVIEW as their software environment for 2015. Following Kickoff, they use the previously-developed C code as a reference for the algorithms and calculations required to implement their omni-directional control solution. Because they developed new LabVIEW code as they ported over their algorithms, this would be permitted.

EXAMPLE 4: A different Team develops a similar solution during the fall, and plans to use the developed software on their competition ROBOT. After completing the software, they post it in a generally accessible public forum and make the code available to all Teams. Because they have made their software publicly available before Kickoff, they can use it on their ROBOT.

EXAMPLE 5: A Team develops a transmission during the fall. After completing the project, they publish the CAD files on a generally accessible public forum and make them available to all Teams. Because they have made the design publicly available before Kickoff, they can use the design to create an identical transmission, fabricated after Kickoff, for use on their 2015 ROBOT.

- R14** All ROBOT elements, with the exception of the WITHHOLDING ALLOWANCE per R17 and COTS items, (including items intended for use during the competition in alternative configurations of the ROBOT) must be bagged and sealed, by 11:59PM local time on Stop Build Day, February 17, 2015 (refer to the [2015 Administrative Manual Section 5: Robot Packaging and Transporting](#) for more details).

- R15** Teams must stay “hands-off” their bagged ROBOT elements during the following time periods:

- A. between Stop Build Day and their first event,
- B. during the period(s) between their events, and
- C. outside of Pit hours while attending events.

Modifying parts at night offsite (e.g. pits have closed and you bring a MECHANISM back to the hotel to fix it) is a violation of R15-C.

Additional time is allowed as follows:

- D. After Kickoff, there are no restrictions on when software may be developed.
- E. On days a team is not attending an event, they may continue development of any items permitted per R17, including items listed as exempt from R17, but must do so without interfacing with the ROBOT.
- F. Teams attending 2-day events may access their ROBOTS per the rules defined in the [2015 Administrative Manual Section 5.6: ROBOT Access Period - for Teams Attending District Events](#).
- G. ROBOTS may be exhibited per [2015 Administrative Manual Section 5.5.3: Robot Displays](#).

4.6 Material Utilization

- R16** Lubricants may be used only to reduce friction within the ROBOT. Lubricants may not contaminate the ARENA or other ROBOTS.
- R17** At an Event, Teams may have access to a static set of FABRICATED ITEMS, not bagged per R14, known as the WITHHOLDING ALLOWANCE, that shall not exceed 30 lbs. to be used to repair and/or upgrade their ROBOT. With permission from another Team, Teams may also have access to FABRICATED ITEMS that are part of that other Team’s WITHHOLDING ALLOWANCE to repair and/or upgrade their ROBOT. The WITHHOLDING ALLOWANCE may only be brought into the Venue when the Team initially loads in at the Event. Items made at an Event do not count towards this weight limit.

This means teams may not store FABRICATED ITEMS outside the pits to be brought to the event at a later time. This set may be changed between events (i.e. a Team may leave a different set of items out of the bag and/or fabricate new items to bring to their next event) provided the total weight of FABRICATED ITEMS brought to the next event does not exceed thirty (30) lbs.

For Teams attending 2-Day Events, these FABRICATED ITEMS may be used during the Robot Access Period and/or brought to the Event, but the total weight may not exceed 30 lbs. FABRICATED ITEMS constructed during the Robot Access Period and bagged with the ROBOT are exempt from this limit.

EXAMPLE 1: A team creates 10 lbs of FABRICATED ITEMS after Stop Build Day. During their first Robot Access Period before their first event, they install these items on the ROBOT and bag them with the ROBOT. The team may bring up to 20 lbs. of FABRICATED ITEMS (which may be items removed from the ROBOT before bagging at the end of the Robot Access Period) with them to the event.

EXAMPLE 2: A team creates 30 lbs of FABRICATED ITEMS after Stop Build Day. During their first Robot Access Period before their first event, they install these items on the ROBOT and bag them with the ROBOT. The team may not bring any FABRICATED ITEMS (including any initially bagged on Stop Build Day and removed during the Robot Access Period) with them to the event.

Items exempt from this limit are:

- A. the OPERATOR CONSOLE,
- B. any ROBOT battery assemblies (as described in R4).

4.7 Motors & Actuators

R18 The only motors and actuators permitted on 2015 FRC ROBOTS include the following:

Table 4-1: Legal Motors

Motor Name	Part Numbers Available	Max Qty Allowed
CIM	FR801-001	6
	M4-R0062-12	
	AM802-001A	
	217-2000	
	PM25R-44F-1005	
	PM25R-45F-1004	
	PM25R-45F-1003	
	PMR25R-45F-1003 PMR25R-44F-1005	
BaneBots Motors	M7-RS775-18 / RS775WC-8514 M7-RS775-12 / RS775PH-6221 M5-RS550-12 / RS550VC-7527 M5-RS550-12-B / RS550VC-7527L	unlimited
AndyMark 9015	am-0912	unlimited
Denso Throttle Control	AE235100-0160	unlimited
VEX BAG and/or mini-CIM	217-3351 217-3371	unlimited
AndyMark PG	am-2161 (alt. PN am-2765) am-2194 (alt. PN am-2766)	unlimited
Automotive Window Motors Automotive Door Motors Automotive Windshield Wiper Motors Automotive Seat Motors	Various	unlimited
Bosch Motor	6004 RA3 353-01	unlimited
Snow Blower Motor	am-2235	unlimited
Electrical solenoid actuators, no greater than 1 in. stroke and rated electrical input power no greater than 10 watts (W) continuous duty at 12 volts (VDC)		unlimited
Hard drive motors or fans that are included in the 2015 Kickoff Kit, 2015 <i>FIRST</i> Choice, are a part of a legal motor controller (including manufacturer provided accessories), or COTS computing device		unlimited
PWM COTS servos with a maximum power rating of 4W each at 6VDC Per the Servo Industry, Servo Max Power Rating = (Stall Torque) X (No Load Speed)		unlimited

This is the total number of each motor a Team may use on their ROBOT, not the quantity per part number. For example, each team may use up to six (6) CIM motors on their ROBOT, regardless of the quantity or combination of each individual part number used.

Given the extensive amount of motors allowed on the ROBOT, Teams are encouraged to consider the total power available from the ROBOT battery during the design and build of the ROBOT. Drawing large amounts of current from many motors at the same time could lead to drops in ROBOT battery voltage that may result in tripping the main breaker or trigger the brownout protection of the roboRIO.

For more information about the roboRIO brownout protection and measuring current draw using the PDP, see [RoboRIO Brownout and Understanding Current Draw](#).

R19 The integral mechanical and electrical system of any motor may not be modified. Motors, servos, and electric solenoids used on the ROBOT shall not be modified in any way, except as follows:

- A. The mounting brackets and/or output shaft/interface may be modified to facilitate the physical connection of the motor to the ROBOT and actuated part.
- B. The electrical input leads may be trimmed to length as necessary.

- C. The locking pins on the window motors (P/N: 262100-3030 and 262100-3040) may be removed.
- D. The connector housings on window, door, windshield wiper or seat motors and Bosch motors (P/N: 6004 RA3 353-01) may be modified to facilitate lead connections.

The intent of this rule is to allow teams to modify mounting tabs and the like, not to gain a weight reduction by potentially compromising the structural integrity of any motor. The integral mechanical and electrical system of the motor is not to be modified.

NOTE that for the previous KOP Window motors and the Bosch motor, the gearbox is considered integral to the motor, thus the motor may not be used without the gearbox.

4.8 Power Distribution

R20 The only legal source of electrical energy for the ROBOT during the competition, the ROBOT battery, must be a non-spillable sealed lead acid (SLA) battery with the following specifications:

- A. Nominal voltage: 12V
- B. Nominal capacity at 20 hour discharge rate: minimum 17Ah, maximum 18.2Ah
- C. Shape: Rectangular
- D. Nominal Dimensions: 7.1 in x 3in. x 6.6 in (+/- .1 in. for each dimension)
- E. Nominal weight: 11lbs to 14.5 lbs
- F. Terminals: Nut and bolt style

EXAMPLES of batteries which meet this criteria include:

Energys (P/N: NP18-12, NP18-12B, NP18-12BFR)

MK Battery (P/N: ES17-12)

Battery Mart (P/N: SLA-12V18)

Sigma (P/N: SP12-18)

Universal Battery (P/N: UB12180)

Power Patrol (P/N: SLA1116)

Werker Battery (P/N: WKA12-18NB)

Power Sonic (P/N: PS-12180NB)

Yuasa (P/N: NP18-12B)

Panasonic (P/N: LC-RD-1217)

Interstate Batteries (P/N: BSL1116)

Teams should be aware that they may be asked to provide documentation of the specifications of any battery not listed above.

Batteries should be charged in accordance with manufacturer's specification. The battery charger output should not exceed 6 amps and they must have the corresponding Anderson connector installed. (Please see the [FIRST Safety Manual](#) for additional information.)

Additionally, batteries integral to and part of a COTS computing device or self-contained camera are also permitted (e.g. laptop batteries, GoPro style camera, etc.), provided they're only used to power the COTS computing device and any peripheral COTS USB input devices connected to the COTS computing device and they are securely fastened to the ROBOT.

R21 No batteries other than those allowed per R20 are allowed on the ROBOT, whether or not they are being used to supply power.

This means teams may not use additional batteries as extra weight on their ROBOTS, for example.

R22 The ROBOT battery must be secured such that it will not dislodge should the ROBOT be turned over or placed in any arbitrary orientation.

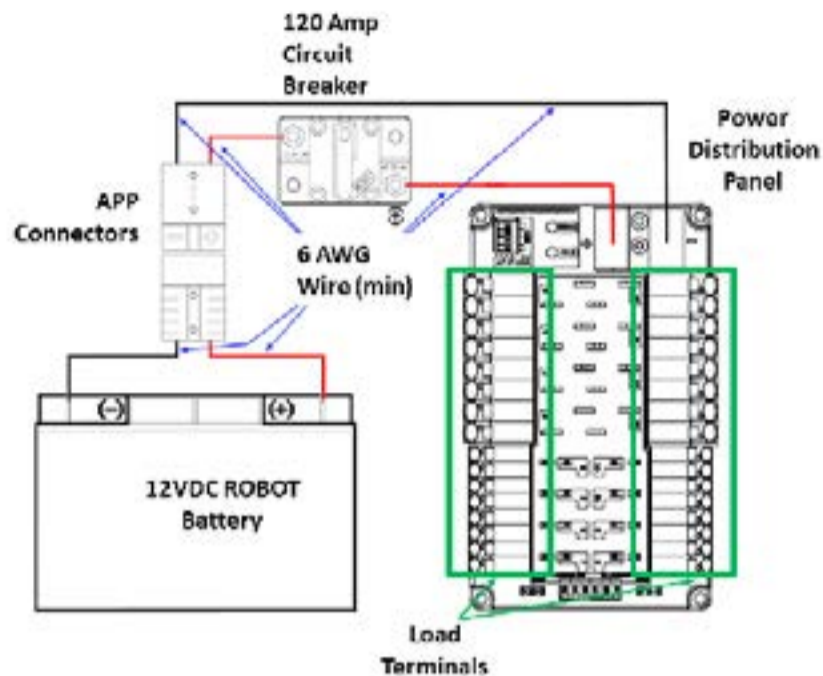
R23 Each electrical terminal on the ROBOT battery, main breaker, and their connection (lugs, stripped wire ends, etc.) to the wire must be fully insulated at all times.

R24 Non-electrical sources of energy used by the ROBOT, (i.e., stored at the start of a MATCH), shall come only from the following sources:

- A. compressed air stored in the pneumatic system that has been charged in compliance with R68 and R69,
- B. a change in the altitude of the ROBOT center of gravity,
- C. storage achieved by deformation of ROBOT parts,
- D. closed-loop COTS pneumatic (gas) shocks, and
- E. air-filled (pneumatic) wheels.

R25 The one (1) ROBOT battery, single pair of Anderson Power Products (or APP) 2-pole SB type connectors, the one (1) main 120-amp (120A) circuit breaker (Cooper Bussman P/N: CB185-120), and the one (1) Cross The Road Electronics Power Distribution Panel (PDP, P/N: am-2856, 217-4244) shall be connected with 6 AWG wire or larger as shown in Figure 4-2.

Figure 4-2: Main Power Distribution



“SB type” refers to SB type only (e.g. SB-50, SB-120, etc.), not SBS or any other part type beginning with SB. All batteries supplied by *FIRST* (such as Spare Parts and international batteries) will have a Red or Pink SB50 connector installed which may not be removed. The pink connectors included in the 2015 KOP mate with the Red SB50 connector.

R26 All circuits, with the exceptions of those listed in R31 and R33, must connect to, and have power sourced solely by, a single protected 12VDC WAGO connector pair (i.e. the Load Terminals, as shown in Figure 4-2) not the M6 cap screws.

R27 All wiring and electrical devices, including all Control System COMPONENTS, shall be electrically isolated from the ROBOT frame. The ROBOT frame must not be used to carry electrical current.

R27 is checked by observing a $>10k\Omega$ resistance between either the (+) or (-) post within the APP connector that is attached to the PDP and any point on the ROBOT.

The Victor-SP and Talon-SRX motor controller cases are electrically isolated. They may be mounted directly to ROBOT frame components.

The Axis 206 camera has a grounded enclosure. Under R27 (and for their protection), it is required that they be electrically isolated from the ROBOT frame when installed on the ROBOT.

R28 The 120A circuit breaker must be quickly accessible from the exterior of the ROBOT. This is the only 120A circuit breaker allowed on the ROBOT.

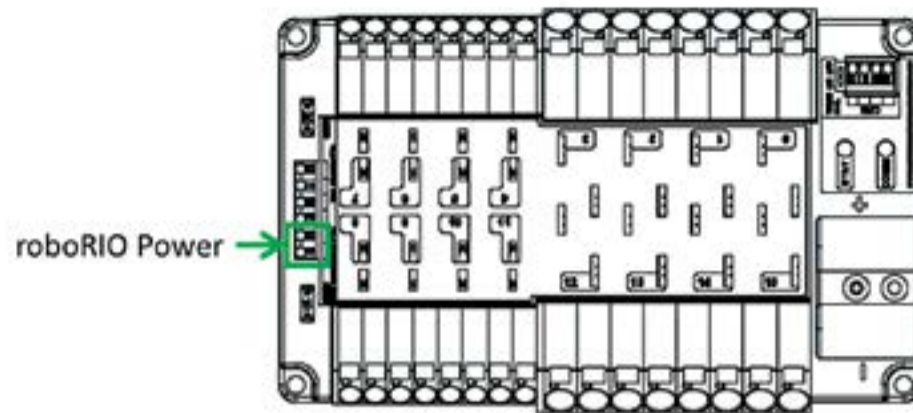
It is recommended that the 120A circuit breaker location be clearly and obviously labeled so it can be easily found by FIELD staff during a MATCH.

R29 The PDP and all circuit breakers must be easily visible for Inspection.

R30 Any active electrical item not explicitly listed in R18 or R55 is considered a CUSTOM CIRCUIT. CUSTOM CIRCUITS may not produce voltages exceeding 24V.

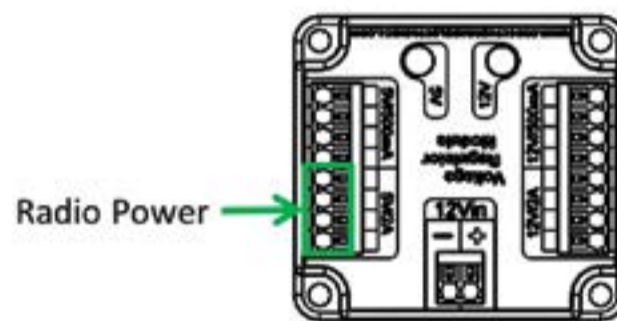
R31 The roboRIO power input must be connected to the dedicated supply terminals on the PDP shown in Figure 4-3. No other electrical load may be connected to these terminals.

Figure 4-3: roboRIO Power Connections



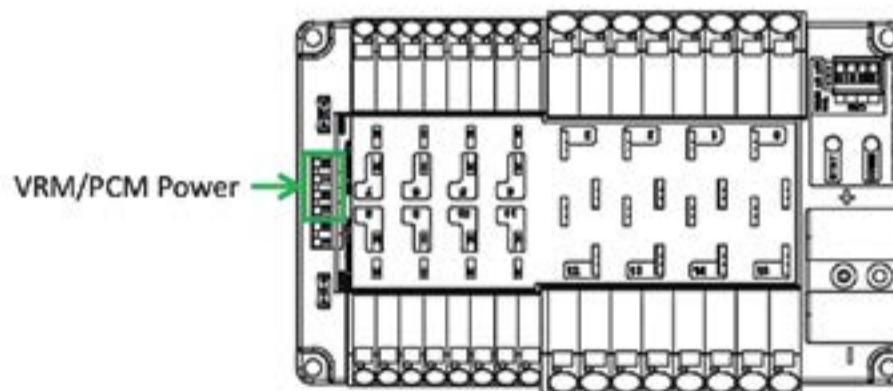
R32 The Wireless Bridge power must be supplied by the 5V 2A ("Radio") output of a Cross the Road Electronics Voltage Regulator Module (VRM) (P/N: am-2857, 217-4245) and must be the only load connected to those terminals.

Figure 4-4: Radio Power Connection



R33 The VRM supplying power to the Wireless Bridge per R32 must be connected to the designated supply terminals at the end of the PDP, and not the main WAGO connectors along the sides of the PDP as shown in Figure 4-5. With the exception of a single Cross the Road Electronics Pneumatics Control Module (PCM, P/N: am-2858), no other electrical load may be connected to these PDP terminals.

Figure 4-5: VRM/PCM Power Connection



Please reference Wiring the [2015 FRC Control System](#) for Wireless Bridge wiring information.

R34 Only one wire may be connected to each WAGO connector on the PDP.

If multi-point distribution of circuit power is needed (e.g. to provide power to multiple PCMs and/or VRMs from one 20A circuit), then all incoming wires may be appropriately spliced into the main lead, and only one lead inserted into the WAGO connector to connect the circuit.

R35 The only circuit breakers permitted for use in the PDP are:

- A. Snap Action VB3-A Series, terminal style F57
- B. Snap Action MX5-A40

R36 The fuses in the PDP may only be replaced with functionally identical fuses (mini automotive blade fuses with values matching those printed on the PDP)

R37 Each branch circuit must be protected by one and only one circuit breaker on the PDP per Table 4-2. No other electrical load can be connected to the breaker supplying this circuit.

Table 4-2: Branch Circuit Protection

Branch Circuit	Circuit Breaker Value	Quantity Allowed Per Breaker
Motor Controller	Up to 40A	1
CUSTOM CIRCUIT	Up to 40A	1
Fans permitted per Table 4-1 and not already part of COTS computing devices	Up to 20A	no limit
Relay Module	Up to 20A	1
PCM – with compressor	20A	1
Additional VRM (non-radio)/Additional PCM (non-compressor)	20A	3 total

R37 does not prohibit the use of smaller value fuses and/or breakers within CUSTOM CIRCUITS for additional protection.

R38 All circuits shall be wired with appropriately sized insulated wire:

Table 4-3: Legal Wire Size

Application	Minimum Wire Size
31 – 40A protected circuit	12 AWG (2.052mm)
21 – 30A protected circuit	14 AWG (1.628mm)
6 – 20A protected circuit	18 AWG (1.024mm)
Between the PDP dedicated terminals and the VRM or PCM	18 AWG (1.024mm)
Compressor outputs from the PCM	18 AWG (1.024mm)
Between the PDP and the roboRIO	22 AWG (0.645mm)
VRM 2A circuits	22 AWG (0.645mm)
≤5A protected circuit	22 AWG (0.645mm)
roboRIO PWM port outputs	26 AWG (0.404mm)
SIGNAL LEVEL circuits (i.e. circuits which draw ≤1A continuous and have a source incapable of delivering >1A, including but not limited to roboRIO non-PWM outputs, CAN signals, PCM Solenoid outputs, VRM 500mA outputs and Arduino outputs)	28 AWG (0.321mm)

Wires that are recommended by the device manufacturer or originally attached to legal devices are considered part of the device and by default legal. Such wires are exempt from R38.

- R39** Branch circuits may include intermediate elements such as COTS connectors, splices, COTS flexible/rolling/sliding contacts, and COTS slip rings, as long as the entire electrical pathway is via appropriately gauged/rated elements.
- R40** All non-SIGNAL LEVEL wiring with a constant polarity (i.e., except for outputs of relay modules, motor controllers, or sensors) shall be color-coded along their entire length (from the manufacturer) as follows:
- A. Red, yellow, white, brown, or black-with-stripe on the positive (e.g. +24VDC, +12VDC, +5VDC, etc.) connections
 - B. Black or blue for the common or negative side (-) of the connections.

Wires that are originally attached to legal devices are considered part of the device and by default legal. Such wires are exempt from R40.

- R41** With the exception of fans or hard drive motors permitted in R18, each actuator must be controlled by a power regulating device. The only power regulating devices for actuators permitted on the ROBOT include:

A. Motor Controllers

- A. Jaguar Motor Controller (P/N: MDL-BDC, MDL-BDC24, and 217-3367)
- B. Talon Motor Controller (P/N: CTRE_Talon, CTRE_Talon_SR, and am-2195)
- C. Talon SRX Motor Controller (P/N: 217-8080), equipped with firmware version 0.28 or newer if using via PWM. See R59 if using via CAN.
- D. Victor 884 Motor Controller (P/N: VICTOR-884-12/12)
- E. Victor 888 Motor Controller (P/N: 217-2769)
- F. Victor SP Motor Controller (P/N: 217-9090)

B. Relay Modules

- A. Spike H-Bridge Relay (P/N: 217-0220 and SPIKE-RELAY-H)

C. Pneumatics controllers

- A. Pneumatics Control Module (P/N: am-2858, 217-4243)

- R42** Each power regulating device may control electrical loads per Table 4-4. Unless otherwise noted, each power regulating device may control one and only one electrical load.

Table 4-4: Legal Power Regulating Device Use

Electrical Load	Motor Controller	Relay Module	Pneumatics Controller
CIM			
AndyMark 9015	Yes	No	No
Banebots			
VEX BAG/MiniCIM			
Automotive Window/Door/Windshield			
Wiper/Seat Motors			
AndyMark PG	Yes Up to 2 per controller	Yes	No
Bosch Motor			
Snow-Blower Motor			
Denso Throttle Control			
Compressor	No	Yes	Yes
Pneumatic Solenoid Valves	No	Yes*	Yes (1 per channel)
Electric Solenoids	No	Yes*	Yes (1 per channel)
CUSTOM CIRCUITS	Yes	Yes*	Yes (1 per channel)

**Multiple low-load, pneumatic solenoid valves, electric solenoids or CUSTOM CIRCUITS may be connected to a single relay module. This would allow one (1) relay module to drive multiple pneumatic actions or multiple CUSTOM CIRCUITS. No other electrical load can be connected to a relay module used in this manner.*

- R43** Servos must be directly connected to the PWM ports on the roboRIO, or through an approved MXP per R58. They may not be connected to motor controllers or relay modules.

- R44** CUSTOM CIRCUITS shall not directly alter the power pathways between the ROBOT battery, PDP, motor controllers, relays, motors and actuators (per R18), pneumatic solenoid valves, or other elements of the ROBOT control system (items explicitly

mentioned in R55). Custom high impedance voltage monitoring or low impedance current monitoring circuitry connected to the ROBOT'S electrical system is acceptable, if the effect on the ROBOT outputs is inconsequential.

4.9 Control, Command & Signals System

R45 ROBOTS must be controlled via one (1) programmable National Instruments roboRIO (P/N: am3000), with image version FRC_2015_v23.

There are no rules that prohibit co-processors, provided commands originate from the roboRIO to configure, enable, and specify all operating points for all power regulating devices. This includes motor controllers legally wired to the CAN-bus.

R46 One (1) D-Link Wireless Bridge (P/N: DAP-1522), hardware revision B, that has been configured with the appropriate encryption key for your team number at each event, is the only permitted device for communicating to and from the ROBOT during the MATCH.

Hardware revision A, distributed in 2011 and 2012, is not legal for 2015.

R47 The DAP-1522 Wireless Bridge must be connected to the roboRIO Ethernet port (either directly or via a CAT5 Ethernet pigtail).

R48 Ethernet-connected COTS devices or CUSTOM CIRCUITS may connect to any remaining Ethernet port on the DAP-1522 Wireless Bridge but must not transmit or receive UDP packets using ports 1100-1200 with the exception of ports 1130 and 1140.

R49 Communication between the ROBOT and the OPERATOR CONSOLE is restricted as follows:

A. Network Ports:

1. TCP 1180: Camera data from the roboRIO to the Driver Station (DS) when the camera is connected the roboRIO via USB, bi-directional.
2. TCP 1735: SmartDashboard, bi-directional
3. UDP 1130: Dashboard-to-ROBOT control data, uni-directional
4. UDP 1140: ROBOT-to-Dashboard status data, uni-directional
5. HTTP 80: Camera connected via switch on the ROBOT, bi-directional
6. HTTP 443: Camera connected via switch on the ROBOT, bi-directional
7. UDP/TCP 554: Real-Time Streaming Protocol for h.264 camera streaming, bi-directional
8. UDP/TCP 5800-5810: Team Use, bi-directional

Teams may use these ports as they wish if they do not employ them as outlined above (i.e. TCP 1180 can be used to pass data back and forth between the ROBOT and the DS if the Team chooses not to use the camera on USB).

B. Bandwidth: no more than 7 Mbits/second.

The [FMS Whitepaper](#) has more details on how to check and optimize bandwidth usage.

Note that while *FIRST* makes every effort to provide a wireless environment that allows teams access to a full 7Mbits/second data rate (with about 100Kbit used for ROBOT control and status), at some events wireless conditions may not accommodate this.

R50 The roboRIO, Driver Station software, and Wireless Bridge must be configured to correspond to the correct Team number, per the procedures defined in [Getting Started with the FRC Control System](#).

R51 All signals must originate from the OPERATOR CONSOLE and be transmitted to the ROBOT via the ARENA Ethernet network.

R52 No form of wireless communication shall be used to communicate to, from, or within the ROBOT, except those required per R46 and R51 (e.g. radio modems from previous *FIRST* competitions and Bluetooth devices are not permitted on the ROBOT during competition).

R53 The Wireless Bridge must be mounted on the ROBOT such that the diagnostic lights are visible to ARENA personnel.

Teams are encouraged to mount the wireless bridge away from noise generating devices such as motors, PCM(s), and VRM(s).

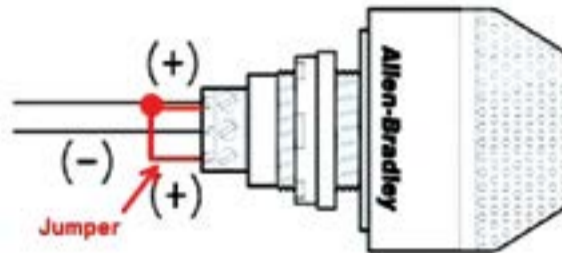
R54 ROBOTS must use at least one (1), but no more than two (2) diagnostic ROBOT Signal Lights (RSL) (P/N: 855PB-B12ME522).

Any RSL must be:

- A. mounted on the ROBOT such that it is easily visible while standing three (3) ft in front of the ROBOT,
- B. connected to the “RSL” supply terminals on the roboRIO,
- C. wired for solid light operation, by placing a jumper between the “La” and “Lb” terminals on the light per Figure 4-6.

Please see [Wiring the 2015 FRC Control System](#) and the item bulletin for connection details.

Figure 4-6: Jumper on RSL



R55 The Driver Station software, roboRIO, Power Distribution Panel, Pneumatics Control Modules, Voltage Regulator Modules, RSL, 120A breaker, motor controllers, relay modules, Wireless Bridge, and batteries shall not be tampered with, modified, or adjusted in any way (tampering includes drilling, cutting, machining, rewiring, disassembling, etc.), with the following exceptions:

Please note that the Driver Station application is a separate application from the Dashboard. The Driver Station software may not be modified, while teams are expected to customize their Dashboard code.

- A. User programmable code in the roboRIO may be customized.
- B. Motor controllers may be calibrated as described in owner’s manuals.
- C. Fans may be attached to motor controllers and may be powered from the power input terminals.
- D. If powering the compressor, the fuse on a Spike H-Bridge Relay may be replaced with a 20A Snap-Action circuit breaker.
- E. Wires, cables, and signal lines may be connected via the standard connection points provided on the devices.
- F. Fasteners (including adhesives) may be used to attach the device to the OPERATOR CONSOLE or ROBOT or to secure cables to the device.
- G. Thermal interface material may be used to improve heat conduction.
- H. Labeling may be applied to indicate device purpose, connectivity, functional performance, etc.
- I. Jumpers may be changed from their default location.
- J. Limit switch jumpers may be removed from a Jaguar motor controller and a custom limit switch circuit may be substituted.
- K. Device firmware may be updated.
- L. Integral wires on the Victor SP or Talon SRX may be cut, stripped, and/or connectorized.
- M. Devices may be repaired, provided the performance and specifications of the device after the repair are identical to those before the repair.

Please note that while repairs are permitted per the FRC Game Manual, the allowance is independent of any manufacturer’s warranty. Teams make repairs at their own risk and should assume that any warranty or RMA options are forfeited. Be aware that diagnosing and repairing COMPONENTS such as these can be difficult.

R56 Neither 12VDC power nor relay module or motor controller outputs may be directly connected to the roboRIO (with the exception of the designated 12VDC input).

- R57** Every relay module, servo, and PWM motor controller shall be connected to a corresponding port (relays to Relay ports, servos and PWM controllers to PWM ports) on the roboRIO or via a legal MXP connection (per R58). They shall not be controlled by signals from any other source.
- R58** If a motor or servo is controlled via the MXP, it (or its power regulating device) must be connected by one of the following methods:
- A. directly to any PWM pins,
 - B. via a network of PASSIVE CONDUCTORS used to extend the PWM pins, or
 - C. via one approved ACTIVE DEVICE:
 - a. Kauai Labs navX MXP
 - b. RCAL MXP Daughterboard
 - c. Rev Robotics RIOduino

The “network of PASSIVE CONDUCTORS” only applies to the pins being used for PWM output to motors or servos. This means that connecting an ACTIVE DEVICE, such as a sensor to one MXP pin does not prevent other MXP pins from being used in accordance with R58-B.

- R59** Each Jaguar or Talon SRX must be controlled with signal inputs sourced from the roboRIO and passed via either a PWM (wired per R57) or CAN-bus (either directly or daisy-chained via another CAN-bus device) signal, but both may not be wired simultaneously on the same device. If the CAN-bus configuration is used, the firmware on the device must be updated to at least the following versions:
- A. Grey Jaguars – v109
 - B. Black Jaguars – v109
 - C. Talon SRX – v1.01.

As long as the CAN bus is wired legally so that the heartbeat from the roboRIO is maintained, all closed loop control features of the Jaguar or Talon SRX motor controller may be used. (That is, commands originating from the roboRIO to configure, enable, and specify an operating point for all Jaguar or Talon SRX closed loop modes fit the intent of R45.)

- R60** Each PCM must be controlled with signal inputs sourced from the roboRIO and passed via a CAN-bus connection from the roboRIO (either directly or daisy-chained via another CAN-bus device). The firmware on each PCM must be updated to at least version 1.62.
- R61** The PDP CAN interface must be connected to the CAN-bus on the roboRIO (either directly or daisy-chained via another CAN-bus device). The firmware on the PDP must be updated to at least version 1.37.

For documentation on how to wire the CAN-bus connections of the PDP see [Wiring the 2015 FRC Control System](#).

- R62** The CAN-bus must be connected to the roboRIO CAN port.
- A. Additional switches, sensor modules, CUSTOM CIRCUITS, third-party modules, etc. may also be placed on the CAN-bus.
 - B. No device that interferes with, alters, or blocks communications among the roboRIO and the Jaguars, PDP, PCMs, and/or Talon-SRXs on the bus will be permitted.

Only one wire should be inserted into each Weidmuller CAN connector terminal. For documentation on how to wire the CAN-bus connections of the roboRIO, PCM, PDP and CAN motor controllers, see [Wiring the 2015 FRC Control System](#).

A noise filter may be wired across motor leads or PWM leads. Such filters will not be considered CUSTOM CIRCUITS and will not be considered a violation of R44 or R62.

Acceptable signal filters must be fully insulated and must be one of the following:

- A. A one microfarad (1 μ F) or less, non-polarized, capacitor may be applied across the power leads of any motor on your ROBOT (as close to the actual motor leads as reasonably possible).

- B. A resistor may be used as a shunt load for the PWM control signal feeding a servo.

4.10 Pneumatic System

- R63** To satisfy multiple constraints associated with safety, consistency, Inspection, and constructive innovation, no pneumatic parts other than those explicitly permitted in *Section 4.10: Pneumatic System* may be used on the ROBOT.
- R64** All pneumatic items must be COTS pneumatic devices rated by their manufacturers for working pressure of at least 125psi (with the exception of R66-D).
- R65** All pneumatic COMPONENTS must be used in their original, unaltered condition. Exceptions are as follows:
- A. tubing may be cut,
 - B. wiring for pneumatic devices may be modified to interface with the control system,
 - C. assembling and connecting pneumatic COMPONENTS using the pre-existing threads, mounting brackets, quick-connect fittings, etc.,
 - D. removing the mounting pin from a pneumatic cylinder, provided the cylinder itself is not modified,
 - E. labeling applied to indicate device purpose, connectivity, functional performance, etc.

Do not, for example, paint, file, machine, or abrasively remove any part of a pneumatic COMPONENT – this would cause the part to become a prohibited item. Consider pneumatic COMPONENTS sacred.

- R66** The only pneumatic system items permitted on 2015 FRC ROBOTS include the items listed below.
- A. Items available in the KOP (except as noted in I),
 - B. Pneumatic pressure vent plug valves functionally equivalent to those provided in the KOP,

Parker valves PV609-2 or MV709-2 are recommended.

- C. Solenoid valves with a maximum 1/8 in. NPT port diameter,
- D. Solenoid valves that are rated for a maximum rated pressure that is less than 125 psi rating mandated above are permitted, however if employed, an additional pressure relief valve must be added to the low pressure side of the main regulator. The additional relief valve must be set to a lower pressure than the maximum pressure rating for the solenoid valve,
- E. Additional pneumatic tubing, with a maximum 0.160 in. inside diameter, functionally equivalent to that provided in the KOP,
- F. Pressure transducers, pressure gauges, passive flow control valves (specifically “needle valves”), manifolds, and connecting fittings,
- G. Pressure regulators with a maximum outlet pressure of no more than 60 psi,
- H. Pneumatic cylinders,
- I. Pneumatic storage tanks (with the exception of White Clippard tanks P/N: AVT-PP-41), and
- J. Compressors compliant with R68.

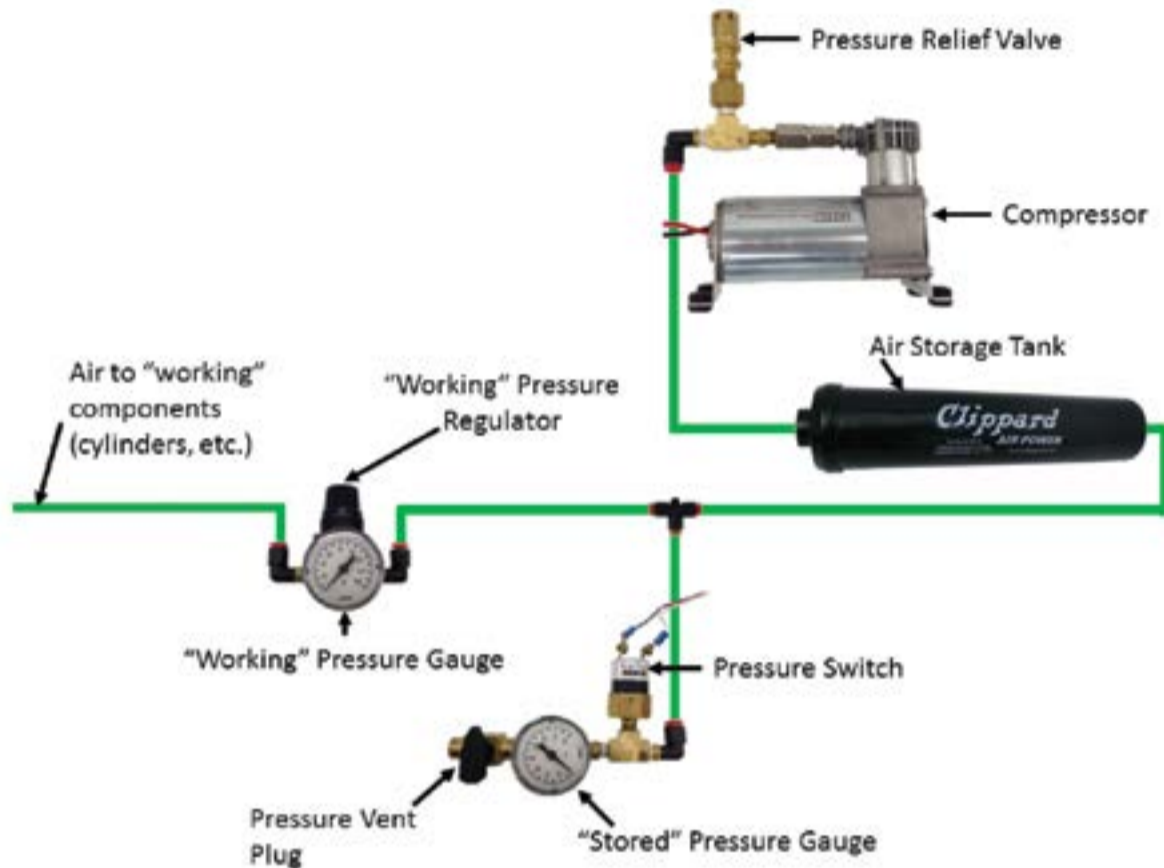
The following devices are not considered pneumatic devices and are not subject to pneumatic rules (though they must satisfy all other rules):

- A. a device that creates a vacuum
- B. closed-loop COTS pneumatic (gas) shocks
- C. air-filled (pneumatic) wheels

R67 If pneumatic COMPONENTS are used, the following items are required as part of the pneumatic circuit and must be used in accordance with this section, as illustrated in Figure 4-7.

- A. Compressor
- B. Pressure relief valve connected via legal rigid fittings (e.g. brass, nylon, etc.)
- C. Nason pressure switch, P/N SM-2B-115R/443
- D. At least one pressure vent plug
- E. “Stored” pressure gauge (upstream from Primary Regulator)
- F. “Working” pressure gauge (downstream from Primary Regulator)
- G. “Working” pressure regulator

Figure 4-7: Pneumatic System Setup



R68 Compressed air on the ROBOT must be provided by one and only one compressor. Compressor specifications may not exceed nominal 12VDC, 1.05 cfm flow rate.

R69 The compressor (permitted per R68) may be located off-board, however the compressor must still be controlled and powered by the ROBOT.

The compressor may be mounted on the ROBOT, or it may be left off the ROBOT and used to pre-charge compressed air in storage tanks on the ROBOT

The intent of this rule is to permit teams to take advantage of the weight savings associated with keeping the compressor off-board. However, using the compressor off-board of the ROBOT does NOT permit non-compliance with any other applicable rules.

R70 “Stored” air pressure on the ROBOT must be no greater than 120 psi. No stored air pressure intended for the ROBOT may be located off-board the ROBOT.

R71 “Working” air pressure on the ROBOT must be no greater than 60 psi and must be provided through one primary adjustable, relieving, pressure regulator.

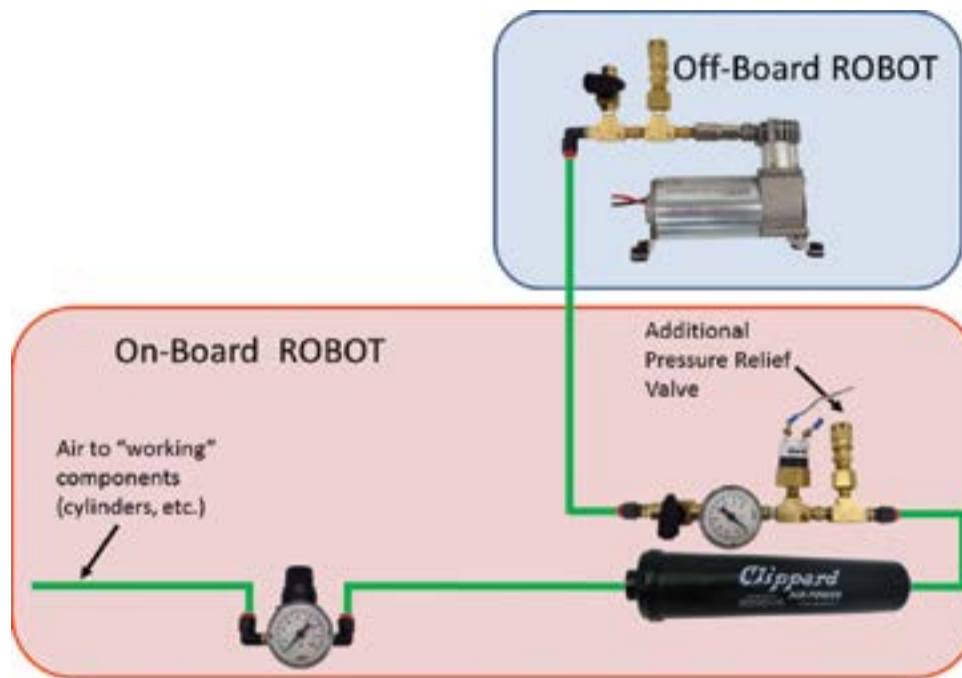
Norgren regulator P/N: R07-100-RNEA or Monnier P/N: 101-3002-1 recommended.

R72 Only the compressor, relief valve (P/N: 16-004-011), pressure switch, pressure vent plug, pressure gauge, storage tanks, tubing, pressure transducers, and connecting fittings may be in the high-pressure pneumatic circuit upstream from the regulator.

R73 Pressure gauges must be placed in easily visible locations upstream and downstream of the regulator to display the “stored” and “working” pressures.

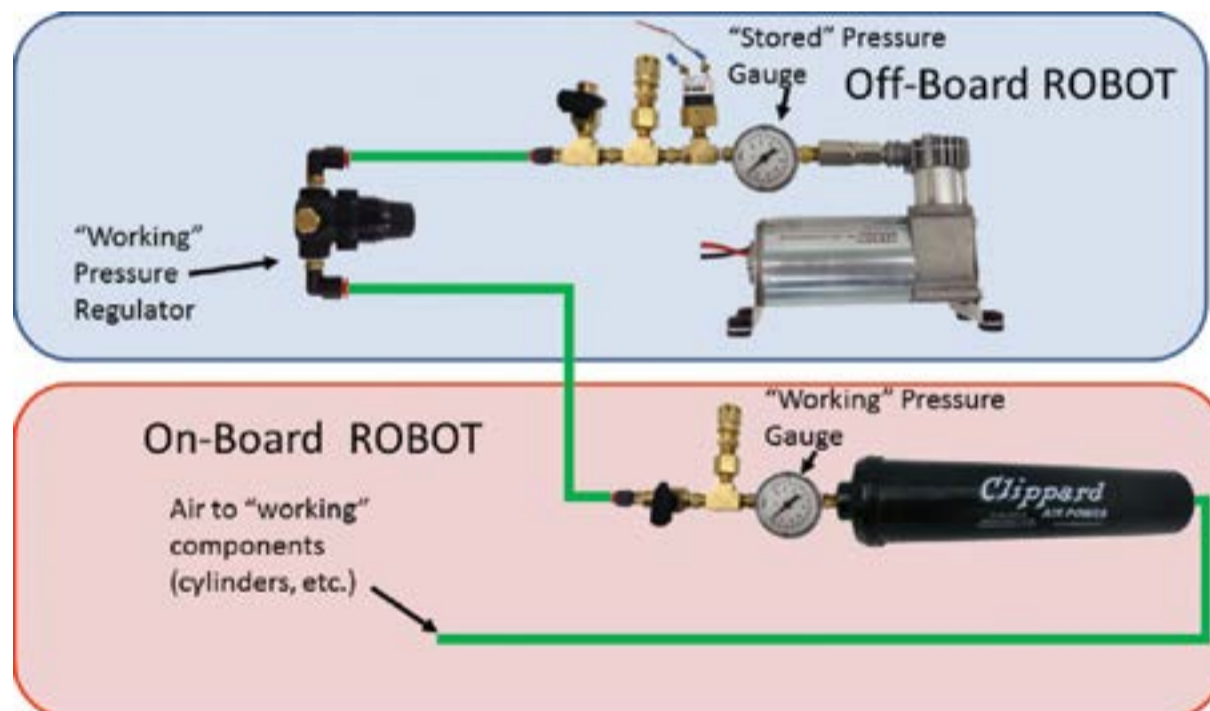
R74 If the compressor is not included on the ROBOT (under the provisions of Rule R68), the “Working” Pressure Regulator, “Stored” Pressure Gauge, and pressure switch may be located on-board (Figure 4-7) or off-board (Figure 4-8) (but must be together), provided all other pneumatic rules are satisfied.

Figure 4-8: Off-Board Compressor with On-Board Regulator and Gauge



R75 If the regulator is kept off-board the ROBOT with the compressor, then only low-pressure (60 psi or less) “working” air can be stored on the ROBOT. The “working” pressure gauge must be installed on-board the ROBOT at all times (Figure 4-8).

Figure 4-9: Off-Board Compressor, Regulator, and Gauge with Additional On-Board Gauge



R76 The relief valve must be attached directly to the compressor or attached by legal hard fittings (e.g. brass, nylon, etc.) connected to the compressor output port. If using an off-board compressor, an additional relief valve must be included on the ROBOT.

If necessary, Teams are required to adjust the relief valve to release air at 125 psi. The valve may or may not have been calibrated prior to being supplied to Teams.

R77 The pressure switch requirements are:

- A. It must be Nason P/N: SM-2B-115R/443
- B. It must be connected to the high-pressure side of the pneumatic circuit (i.e. prior to the pressure regulator) to sense the “stored” pressure of the circuit.
- C. The two wires from the pressure switch must be connected directly the pressure switch input of the PCM controlling the compressor or, if controlled using the roboRIO and a Spike relay, to the roboRIO.
- D. If connected to the roboRIO, the roboRIO must be programmed to sense the state of the switch and operate the relay module that powers the compressor to prevent over-pressuring the system.

R78 Any pressure vent plug must be:

- A. connected to the pneumatic circuit such that, when manually operated, it will vent to the atmosphere to relieve all stored pressure in a reasonable amount of time, and
- B. placed on the ROBOT so that it is visible and easily accessible.

If the compressor is not used on the ROBOT, then an additional pressure vent plug must be connected to the high-pressure portion of the pneumatic circuit off-board the ROBOT with the compressor (see R68).

R79 The outputs from multiple valves may not be plumbed together.

4.11 OPERATOR CONSOLE

R80 The Driver Station software provided on the [National Instruments website](#) is the only application permitted to specify and communicate the operating mode (i.e. Autonomous/TELEOP) and operating state (Enable/Disable) to the ROBOT. The Driver Station software must be revision 08021500 or newer.

Teams are permitted to use a portable computing device of their choice (laptop computer, PDAs, etc.) to host the Driver Station software while participating in competition MATCHES.

R81 The OPERATOR CONSOLE must include a graphic display to present the Driver Station diagnostic information. It must be positioned within the OPERATOR CONSOLE so that the screen display can be clearly seen during Inspection and in a MATCH.

R82 Devices hosting the Driver Station software may only interface with the Field Management System (FMS) via the Ethernet cable provided at the PLAYER STATION (e.g. not through a switch). Teams may connect the FIELD Ethernet cable to their Driver Station device directly, via an Ethernet pigtail, or with a single-port Ethernet converter (e.g. docking station, USB-Ethernet converter, Thunderbolt-Ethernet converter, etc.). The Ethernet port on the OPERATOR CONSOLE must be easily and quickly accessible.

Teams are strongly encouraged to use pigtails on the Ethernet port used to connect to the FMS. Such pigtails will reduce wear and tear on the device's port and, with proper strain relief employed, will protect the port from accidental damage.

R83 The OPERATOR CONSOLE must not exceed 60 in. long by 14 in. deep (excluding any items that are held or worn by the DRIVERS during the MATCH).

There is a 54 in. long by 2 in. wide strip of hook-and-loop tape (“loop” side) along the center of the PLAYER STATION support shelf that may be used to secure the OPERATOR CONSOLE to the shelf. See [SECTION 2.2.1: PLAYER STATIONS](#) for details.

R84 Other than the system provided by the ARENA, no other form of wireless communications shall be used to communicate to, from, or within the OPERATOR CONSOLE.

Examples of prohibited wireless systems include, but are not limited to, active wireless network cards and Bluetooth devices. For the case of FRC, a motion sensing input device (e.g. Microsoft Kinect) is not considered wireless communication and is allowed.

5

The Tournament

5.0	The Tournament	49
5.1	Overview	50
5.1.1	MATCH Schedules	50
5.2	Practice MATCHES	50
5.2.1	Schedule	50
5.2.2	Filler Line	51
5.3	Qualification MATCHES	51
5.3.1	Schedule	51
5.3.2	MATCH Assignment	51
5.3.3	Qualification Average (QA)	51
5.3.4	Qualification Seeding	52
5.4	Playoff MATCHES	52
5.4.1	ALLIANCE Selection Process	52
5.4.2	BACKUP TEAMS	53
5.4.3	Playoff Scoring	53
5.4.4	Playoff MATCH Format	54
5.4.5	Pit Crews	54
5.5	Tournament Rules	54
5.5.1	Safety and Security Rules	54
5.5.2	Eligibility and Inspection	55
5.5.3	REFEREE Interaction	56
5.5.4	YELLOW and RED CARDS	57
5.5.5	MATCH REPLAYS	57
5.5.6	TIMEOUT and BACKUP TEAM Rules	58
5.5.7	Measurement	59
5.5.8	Special Equipment Rules	59
5.6	Championship Additions and Exceptions	59
5.6.1	Four ROBOT ALLIANCES	59
5.6.2	Championship Pit Crews	60
5.6.3	FRC Championship MATCH Bracket	60

FIRST®, the FIRST® logo, FIRST® Robotics Competition, FRC®, FIRST® Tech Challenge, Coopertition®, Gracious Professionalism®, and RECYCLE RUSHSM are trademarks of the United States Foundation for Inspiration and Recognition of Science and Technology (FIRST®). FIRST® LEGO® League is a jointly held trademark of FIRST and the LEGO Group. LEGO® is a registered trademark of the LEGO Group. © 2015 FIRST. All rights reserved.

5 THE TOURNAMENT

RECYCLE RUSH is played by two (2) ALLIANCES of three (3) Teams each who compete simultaneously to score points by stacking TOTES, placing RECYCLING CONTAINERS on top of stacked TOTES, and disposing of LITTER retrieved from their respective ALLIANCE STATIONS. This section contains details that apply to the progression of the event, from Practice MATCHES through the Playoff Tournament.

5.1 Overview

Each 2015 *FIRST* Robotics Competition (FRC) event is played in a tournament format. Each tournament consists of three sets of MATCHES called “Practice MATCHES” (not necessarily at all District Events), “Qualification MATCHES,” and “Playoff MATCHES.”

Practice MATCHES provide each Team with an opportunity to operate its ROBOT on the FIELD prior to the start of the Qualification MATCHES.

Qualification MATCHES allow each Team to earn a seeding position that may qualify them for participation in the Playoff MATCHES.

Playoff MATCHES determine the event Champions.

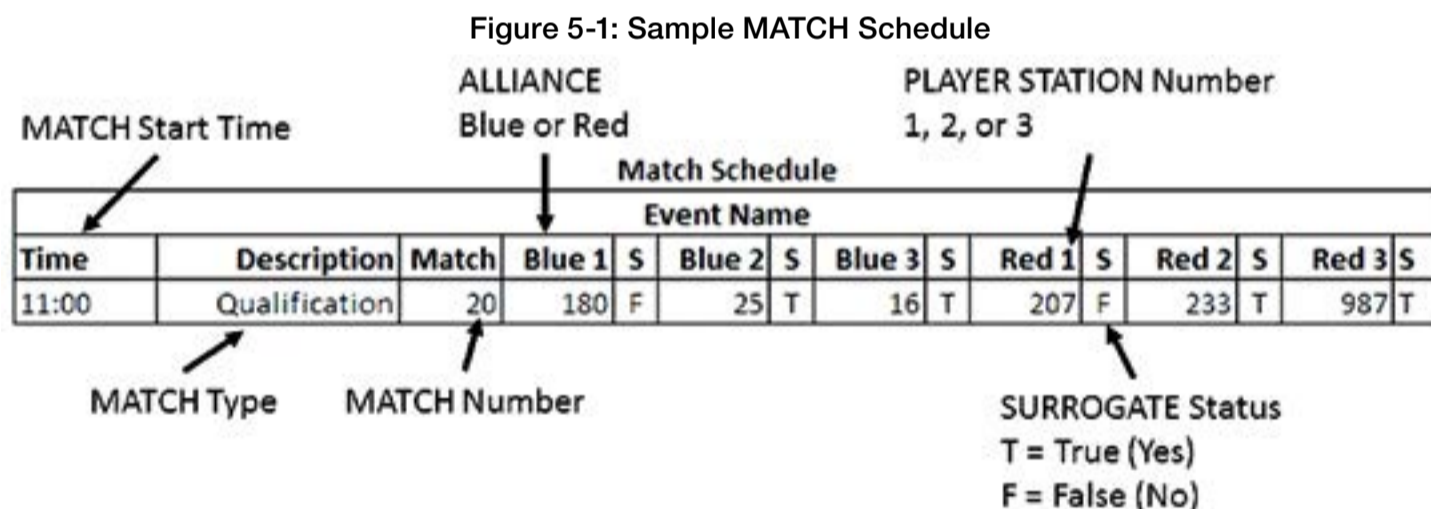
Veterans will note that this year we’ve transitioned from using the term ‘Elimination Matches’ to using the term ‘Playoff Matches’. ‘Elimination’ sounds very final, and while teams that don’t progress through the final matches may no longer be participating in the competition on the field, they may still be contenders for some of the most important awards in FRC.

Each MATCH is conducted with approximately two (2)-minutes for set up, two (2) minutes and thirty (30) seconds of game play, and one (1)-minute FIELD Reset Period to clear the FIELD after each MATCH. During FIELD Reset the ARENA must be cleared of ROBOTS and OPERATOR CONSOLES from the MATCH that just ended. The ROBOTS and OPERATOR CONSOLES for the following MATCH must be placed in position and ready to operate before the start of the next MATCH. FIELD staff will reset the ARENA elements during this time.

If order placement of ROBOTS matters to either or both ALLIANCES, the ALLIANCE must notify the Head REFEREE during setup for that MATCH. Upon notification, the Head REFEREE will require ALLIANCES to alternate placement of their ROBOTS, starting with the Red ALLIANCE.

5.1.1 MATCH Schedules

A MATCH schedule is used to coordinate MATCHES at an Event. Figure 5-1 details information shown on each Schedule.



5.2 Practice MATCHES

5.2.1 Schedule

Practice MATCHES are played on the first day of each event. The Practice MATCH schedule is available as soon as possible, but no later than the start of Practice MATCHES. Practice MATCHES are randomly assigned, and teams may not switch scheduled Practice MATCHES. Each Team is assigned an equal number of Practice MATCHES unless the number of Teams multiplied by number of Practice MATCHES is not divisible by six. In this case, the FIELD Management System (FMS) randomly selects some Teams to play an extra Practice MATCH.

Practice MATCHES are not guaranteed at District Events.

5.2.2 Filler Line

A Filler Line is used to fill open slots at events that employ scheduled Practice MATCHES, or all spots at events with an in open Practice MATCH schedule.

Teams wanting additional Practice MATCHES may join the Filler Line if the criteria listed below are met. Teams from the Filler Line are used on a first come, first served basis to fill empty spots in Practice MATCHES left by other Teams that do not report to Queueing. The number of Teams in the Filler Line is dependent upon space at venues. The criteria for joining the Filler Line are as follows:

- A. ROBOTS in the Filler Line must have passed Inspection;
- B. DRIVE TEAMS must join the Filler Line with their ROBOT;
- C. Teams may not work on their ROBOT while in the Filler Line;
- D. Teams may not occupy more than one spot in the Filler Line; and
- E. If a Team is queued up for their Practice MATCH, they may not also join the Filler Line.

5.3 Qualification MATCHES

5.3.1 Schedule

The Qualification MATCH schedule is made available as soon as possible, but no later than one (1) hour before Qualification MATCHES are scheduled to begin.

5.3.2 MATCH Assignment

FMS assigns each Team two (2) ALLIANCE partners for each Qualification MATCH using a predefined algorithm. The algorithm employs the following criteria, listed in order of priority:

1. Maximize time between each MATCH played for all Teams
2. Minimize the number of times a Team plays opposite any Team
3. Minimize the number of times a Team is allied with any Team
4. Minimize the use of SURROGATES
5. Provide even distribution of MATCHES played on Blue and Red ALLIANCE

All Teams are assigned the same number of Qualification MATCHES, unless the number of Teams multiplied by number of MATCHES is not divisible by six. In this case, the FMS randomly selects some Teams to play an extra MATCH. For the purpose of seeding calculations, those Teams are designated as SURROGATES for the extra MATCH. If a Team plays a MATCH as a SURROGATE, it is indicated on the MATCH schedule, it is always their third Qualification MATCH, and the outcome of the MATCH has no affect on the Team's ranking.

5.3.3 Qualification Average (QA)

MATCH Points are awarded to each eligible Team at the completion of each Qualification MATCH:

- A. Each Team receives MATCH Points equal to their ALLIANCE's final score.

Exceptions to A are as follows:

- B. A SURROGATE receives zero (0) MATCH Points.
- C. A DISQUALIFIED Team (including via a RED CARD) receives zero (0) MATCH Points. During the Qualification MATCHES, Teams may be individually DISQUALIFIED in a MATCH.
- D. A "no-show" Team is DISQUALIFIED from that MATCH and receives zero (0) MATCH Points. A Team is declared a no-show if no member of the DRIVE TEAM is in the ALLIANCE STATION at the start of the MATCH.

The total number of MATCH Points earned by a Team throughout their Qualification MATCHES, divided by their number of assigned MATCHES (excluding any SURROGATE MATCHES), then truncated to two decimal places, is their Qualification Average (QA).

5.3.4 Qualification Seeding

All Teams participating in the Tournament are seeded during the Qualification MATCHES. If the number of Teams in attendance is 'n', they are seeded '1' through 'n', with '1' being the highest seeded Team and 'n' being the lowest seeded Team.

NOTE that a Team's win-loss-tie record in the Qualification tournament does not affect their ranking.

FMS ranks all Teams in decreasing order, using the following sorting criteria:

Table 5-1: Qualification MATCH Ranking Criteria

1st order sort	Qualification Average
2nd order sort	Cumulative sum of Coopertition Points
3rd order sort	Cumulative sum of AUTO points
4th order sort	Cumulative sum of scored RECYCLING CONTAINER points
5th order sort	Cumulative sum of scored TOTE points
6th order sort	Cumulative sum of scored LITTER points (LITTER in a scored RECYCLING CONTAINER + LITTER scored in the ALLIANCE'S LANDFILL ZONE + UNPROCESSED LITTER Bonus)
7th order sort	Random sorting by the FMS

5.4 Playoff MATCHES

At the end of the Qualification MATCHES, the top eight (8) seeded Teams become the ALLIANCE Leads. The top seeded ALLIANCES are designated, in order, ALLIANCE One, ALLIANCE Two, etc., down to ALLIANCE Eight. Using the ALLIANCE selection process described below, each ALLIANCE Lead chooses two (2) other Teams to join their ALLIANCE. If a team declines the ALLIANCE Lead position or doesn't send a representative for ALLIANCE selection, they are ineligible to participate in the rest of the Tournament. If the declining/absent team would have been an ALLIANCE Lead, all lower ranked ALLIANCE Leads are promoted one spot. The next highest-seeded team moves up to become the ALLIANCE Eight Lead.

5.4.1 ALLIANCE Selection Process

Each Team chooses a student Team Representative who will proceed to the ARENA at the designated time (typically before the lunch break on the final day of the event) to represent their Team. The Team Representative from each ALLIANCE Lead is called the ALLIANCE CAPTAIN.

The ALLIANCE selection process consists of two (2) rounds during which each ALLIANCE CAPTAIN invites a Team seeded below them in the standings to join their ALLIANCE. The invited Team must not already have declined an invitation.

Round 1: In descending order (ALLIANCE One to ALLIANCE Eight), each ALLIANCE CAPTAIN invites a single Team. The invited Team's Representative steps forward and either accepts or declines the invitation.

If the Team accepts, it becomes a member of that ALLIANCE. If an invitation from a top eight ALLIANCE to another ALLIANCE Lead is accepted, all lower ALLIANCE Leads are promoted one spot. The next highest-seeded, unselected Team moves up to become the ALLIANCE Eight Lead.

If the Team declines, that Team is not eligible to be picked again or to be a BACKUP TEAM, and the ALLIANCE CAPTAIN extends another invitation to a different Team. If an invitation from a top eight ALLIANCE to another ALLIANCE Lead is declined, the declining Team may still invite Teams to join their ALLIANCE; however, it cannot accept invitations from other ALLIANCES.

The process continues until ALLIANCE Eight makes a successful invitation.

Round 2: The same method is used for each ALLIANCE CAPTAIN'S second choice except the selection order is reversed, with ALLIANCE Eight picking first and ALLIANCE One picking last. This process results in eight (8) ALLIANCES of three (3) Teams each.

5.4.2 BACKUP TEAMS

Of the remaining eligible Teams, the highest seeded Teams (up to eight (8)) should remain on standby and be ready to play as a BACKUP TEAM. If a ROBOT from any ALLIANCE in a Playoff Tournament becomes inoperable, the ALLIANCE CAPTAIN may have the highest seeded Team still available join the ALLIANCE. The resulting ALLIANCE is then composed of four (4) Teams. The replaced Team remains part of the ALLIANCE for awards but cannot return to play, even if their ROBOT is repaired.

Each ALLIANCE has only one opportunity to draw from the pool of remaining Teams. If a second ROBOT from the ALLIANCE becomes inoperable, then the ALLIANCE must play the following MATCHES with only two (2) (or even one (1)) ROBOTS.

EXAMPLE: Three (3) Teams, A, B and C, form an ALLIANCE going into the Playoff MATCHES. The highest seeded Team not on one of the eight (8) ALLIANCES is Team D. During one of the Playoff MATCHES, Team C's ROBOT becomes inoperable. The ALLIANCE CAPTAIN decides to bring in Team D to replace Team C. Team C and their ROBOT may not play in any subsequent Playoff MATCHES.

In the case where a BACKUP TEAM is part of the Champion or Finalist ALLIANCE, there will be a four (4)-Team Champion or Finalist ALLIANCE.

5.4.3 Playoff Advancement

Eight (8) ALLIANCES will play two (2) MATCHES each during the Quarterfinals. The top four (4) Quarterfinal ALLIANCES advance to the Semi-Finals where they each play three (3) more MATCHES. The top two (2) Semi-Final ALLIANCES advance to the Finals where the winning ALLIANCE is determined.

Quarterfinals and Semi-Finals

In the Quarter- and Semifinal MATCHES of the Playoff Tournament, each ALLIANCE earns Match Points as described in [Section 5.3.3: Qualification Average \(QA\)](#). The total number of MATCH Points earned by an ALLIANCE in each level of the Playoffs, divided by the number of MATCHES in that level, then truncated to two decimal places, is their Average Score.

In the Quarterfinals, the ALLIANCES with the four (4) highest Average Scores after two (2) MATCHES will advance. In the Semi-Finals, the ALLIANCES with the two (2) highest Average Scores after three (3) MATCHES will advance.

In other words, after the Quarterfinals, the four (4) ALLIANCES with the highest average scores in their Quarterfinal MATCHES will advance to the Semifinals. Average scores are then all reset to zero (0). After the Semifinals, the two (2) ALLIANCES with the highest average scores during the Semifinal MATCHES will advance to the Finals.

In the case where the average score of two (2) or more ALLIANCES is equal, the higher position is awarded using the tiebreaker rules shown in Table 5-2.

Table 5-2: Quarterfinal and Semifinal MATCH Ranking Criteria

1st order sort	Playoff Average
2nd order sort	Cumulative sum of AUTO points
3rd order sort	Cumulative sum of scored RECYCLING CONTAINER points
4th order sort	Cumulative sum of scored TOTE points
5th order sort	Cumulative sum of scored LITTER points (LITTER in a scored RECYCLING CONTAINER + LITTER scored in the ALLIANCE'S LANDFILL ZONE + UNPROCESSED LITTER Bonus)
6th order sort	ALLIANCE Rank upon entering the Playoff Level (e.g. ranks 1-8 entering the Quarterfinals or 1-4 entering the Semifinals)

Finals

In the Finals MATCHES of the Playoffs, Teams do not earn MATCH Points; they earn a Win, Loss or Tie. The first ALLIANCE to win two (2) MATCHES is the Champion. There are no tie breaker rules awarding additional MATCH points during Final MATCHES. If after two (2) MATCHES the ALLIANCES each have a win, a third MATCH will be played. Additional matches will be played if needed.

The only place in the Tournament in which Win, Loss, or Tie matters is in the Finals

5.4.4 Playoff MATCH Format

The Playoff MATCHES take place following the completion of the Qualification MATCHES and the ALLIANCE selection process. Playoff MATCHES are played as shown in Figure 5-2, ALLIANCE One, ALLIANCE Two, etc. are abbreviate A1, A2, etc.

The higher seeded ALLIANCE will always be assigned to the Red side of the FIELD. Additionally, ALLIANCE CAPTAINS will always be assigned to the center PLAYER STATION, the first pick will be assigned to the station to their left while they're facing the FIELD, and the second pick will be assigned to their right while they're facing the FIELD. If a BACKUP TEAM is in play, they will be assigned to the PLAYER STATION that was assigned to the DRIVE TEAM they're replacing.

In order to allow time between MATCHES for all ALLIANCES, the order of play is as follows:

- **Round 1:** QF1 (A4 vs. A5), QF2 (A3 vs. A6), QF3 (A2 vs. A7), QF4 (A1 vs. A8)
- **Round 2:** QF5 (A4 vs. A6), QF6 (A3 vs. A5), QF7 (A2 vs. A8), QF8 (A1 vs. A7),

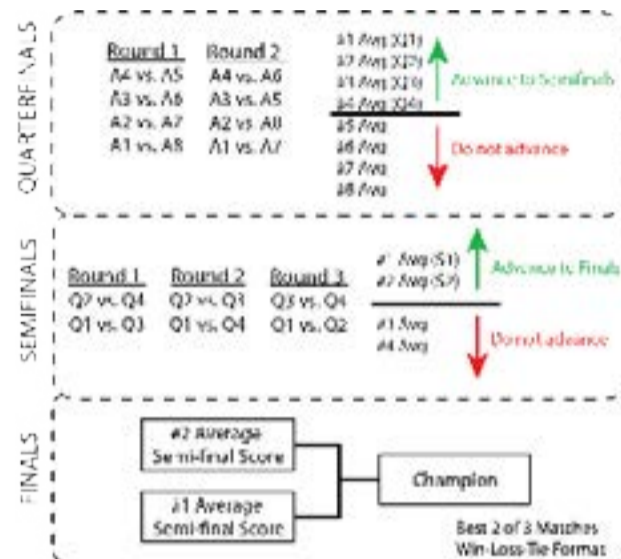
- **Round 1:** SF1 (Q2 vs. Q4), SF2 (Q1 vs. Q3),
- **Round 2:** SF3 (Q2 vs. Q3), SF4 (Q1 vs. Q4)
- **Round 3:** SF5 (Q3 vs. Q4), SF6 (Q1 vs. Q2)

- F1, F2, F3*

Any additional Final MATCHES due to ties*

* IF REQUIRED.

Figure 5-2: Playoff MATCH Format



5.4.5 Pit Crews

During the Playoff MATCHES, extra Team members may be needed to maintain the ROBOT between MATCHES because of the distance between the FIELD and the pit area. For this reason, each Team is permitted to have three (3) additional "pit crew" members who can also help with needed ROBOT repairs/maintenance. Pit Crew members cannot be in the ALLIANCE STATION during a MATCH.

5.5 Tournament Rules

Safety is paramount at all times during the Tournament. Event staff have the final decision authority for all safety-related issues within the venue.

5.5.1 Safety and Security Rules

- T1** Safety is paramount at all times during the Tournament. Event staff have the final decision authority for all safety-related issues within the venue. All event attendees must wear safety glasses and closed-toed shoes while in the ARENA.
- T2** Wireless ROBOT control is only permitted on the FIELD or Practice Field. ROBOTS must be operated by tether when outside the FIELD or Practice Field.
- T3** If operating wirelessly on the Practice Field, ROBOTS must use the provided Practice Field radio for communication.
- T4** Teams may not set up their own 802.11a/b/g/n/ac (2.4GHz or 5GHz) wireless communication (e.g. access points or ad-hoc networks) in the venue.

A wireless hot spot created by a cellular device is considered an access point.

- T5** No Team or Team member shall interfere or attempt to interfere with any other Team's or FIRST's wireless communication. Except as expressly allowed for purposes of communicating with the Team's own ROBOT on the FIELD or a Practice Field, no Team or Team member shall connect or attempt to connect to any other Team's or FIRST's wireless network.

VIOLATION: Up to and including removal of the Team from the event. Legal action may also be pursued based on applicable law.

Teams are encouraged to report suspected wireless security vulnerabilities to the FIRST Technical Advisor (FTA) if at the event or to FIRST via the [Wireless Security Feedback Form](#).

- T6** While transferring the ROBOT throughout the event (e.g. between the Team's Pit, Practice Field, ARENA, Inspection Station, etc.), the ROBOT must not exceed a volume that is 28 in. wide x 42 in. long x 78 in. tall (the TRANSPORT CONFIGURATION).

The intent of T6 and the TRANSPORT CONFIGURATION is to make sure that the absence of footprint size restrictions for a ROBOT in the 2015 season does not result in large, unwieldy ROBOTS being pushed through crowded pits. ROBOT parts occasionally transported outside of the TRANSPORT CONFIGURATION will be overlooked, e.g. a battery, cable ties, Ethernet cords, etc.

Teams may have more than one TRANSPORT CONFIGURATION for their ROBOT.

- T6-1** The OPERATOR CONSOLE must be used in the PLAYER STATION to which the Team is assigned, as indicated on the Team sign.

VIOLATION: The MATCH will not start until the situation is corrected. If during a MATCH and repeated or egregious, YELLOW CARD.

One intent of T6-1 is to prevent unsafe situations where long tethers to OPERATOR CONSOLE devices increase tripping hazards as the operator moves about the ALLIANCE STATION. In the interest of avoiding nuisance penalties associated with an operator stepping outside of a prescribed area, we prefer to offer a general guideline as to what it means to use the OPERATOR CONSOLE in the PLAYER STATION. Provided the operator is within close proximity of their PLAYER STATION, there will be no repercussions. However, if an operator is located more than approximately 1/2 PLAYER STATION width away from their own PLAYER STATION, that would be considered a violation of T6-1.

5.5.2 Eligibility and Inspection

At each event, the Lead ROBOT Inspector (LRI) has final authority on the legality of any COMPONENT, MECHANISM, or ROBOT. Inspectors may re-Inspect ROBOTS to ensure compliance with the rules.

ROBOTS are permitted to participate in scheduled Practice MATCHES prior to passing Inspection. However, the *FIRST* Technical Advisor (FTA), LRI or Head REFEREE may determine at any time that the ROBOT is unsafe, per [Section 3.2.1: Safety](#), and may prohibit further participation in Practice MATCHES until the condition is corrected and the ROBOT passes Inspection.

If a ROBOT will not report for a QUALIFICATION or PLAYOFF MATCH, the Lead Queuer should be informed and at least one (1) member of the DRIVE TEAM should report to the FIELD for the MATCH to avoid receiving a RED CARD, with the exception of a Team that has not passed Inspection, per Rule T8.

- T7** Each registered FRC team may enter only one (1) ROBOT (or 'Robot', which to a reasonably astute observer, is a Robot built to play RECYCLE RUSH) into the 2015 *FIRST* Robotics Competition.

This rule does not prohibit teams from bringing in *FIRST* LEGO League or *FIRST* Tech Challenge robots for the purposes of awards presentations or pit displays.

- T8** A Team is only permitted to participate in a Qualification or Playoff MATCH and receive Match Points if their ROBOT has passed an initial, complete Inspection.

VIOLATION: If prior to the start of the MATCH, the Team is not eligible to participate in the MATCH. If after the start of the MATCH, the entire ALLIANCE receives a RED CARD for that MATCH.

Please take note of this rule. It is important that FRC Teams ensure their ALLIANCE partners have passed Inspection. Allowing a partner that has not passed Inspection to play puts the ALLIANCE at risk of DISQUALIFICATION. Teams should check with their ALLIANCE partners early, and help them pass Inspection before competing.

Sending DRIVE TEAM members to the ARENA without the ROBOT is considered participating in a MATCH.

- T9** At the time of Inspection, the ROBOT must be presented with all MECHANISMS (including all COMPONENTS of each MECHANISM), configurations, and decorations that will be used on the ROBOT during the competition event. It is acceptable, however, for a ROBOT to play MATCHES with a subset of the MECHANISMS that were present during Inspection. Only MECHANISMS that were present during the Inspection may be added, removed or reconfigured between MATCHES. If MECHANISMS are changed between MATCHES the reconfigured ROBOT must still meet all Inspection criteria.
- T10** If a ROBOT is modified after it has passed its most recent Inspection, other than modifications listed in A through F, that ROBOT must be re-Inspected before the ROBOT is eligible to participate in a MATCH. If any of the exceptions listed below result in a significant change to the ROBOT'S size, weight, legality, or safety, the ROBOT must be re-Inspected. When in doubt, the Team should ask to be re-Inspected.
- A. Addition, relocation, or removal of fasteners (e.g. cable ties, tape, and rivets)

- B. Addition, relocation, or removal of labeling or marking
- C. Revision of ROBOT code
- D. A replacement of a COTS component with an identical COTS component
- E. A replacement of a MECHANISM with an identical MECHANISM (size, weight, material)
- F. Additions, removals, or reconfiguration of ROBOT with a subset of MECHANISMS already Inspected per T9

EXAMPLE 1: Team A's ROBOT has passed Inspection, but burns out a motor controller during a MATCH. Team A replaces it with an identical motor controller. Team A does not have to get their ROBOT re-Inspected per exception D in rule T10.

EXAMPLE 2: Team B would like to add weight to their ROBOT to lower their center of gravity. Team B adds a large amount of fasteners to their ROBOT as ballast. Team B must get their ROBOT re-Inspected because they have significantly changed their weight per T10.

EXAMPLE 3: Team C's numbers are beginning to fall off their ROBOT. They use a few pieces of clear tape to secure the numbers. Team C does not have to get their ROBOT re-Inspected per exception A in rule T10.

EXAMPLE 4: Team D has decided to move their motor controller to a different location on their ROBOT, and must use a different length wire to make the proper connections. Team D must get their ROBOT re-Inspected because rewiring is not an exception in T10.

EXAMPLE 5: Team E decides to relocate their battery on their ROBOT to change their center of gravity. Team E must be re-Inspected as the relocation of COMPONENTS or MECHANISMS is not an exception in T10.

EXAMPLE 6: Team F realizes they can gain necessary functionality by building a new MECHANISM at an event and adding it to their ROBOT. Their ROBOT must be re-Inspected.

If an observation is made that another Team's ROBOT may be in violation of the ROBOT rules, please approach *FIRST* officials to review the matter in question. This is an area where Gracious Professionalism is very important.

- T11** The ROBOT Bill of Materials (BOM), listing all items on the ROBOT except those listed in R9-A and -B, and their relevant costs per [Section 4.4: Budget Constraints](#), must be presented at the time of Inspection.

Teams are encouraged to use the BOM Template posted on the [FIRST website](#). Please note that while BOMs must be shown to Inspectors, Teams are not required to submit their BOMs to the Inspectors.

- T12** During the event, from load-in on the first day to load-out on the final day, Teams may only produce FABRICATED ITEMS in the pit areas or provided machine shops, as defined in the [Administrative Manual, Section 4.8: The Pit](#), and per R17 in [Section 4.6: Material Utilization](#).

- T13** For the safety of all those involved, Inspections must take place with the ROBOT powered off, pneumatics unpressurized, and springs or other stored energy devices in their lowest potential energy states (e.g. battery removed).

Power and air pressure should only be enabled on the ROBOT during those portions of the Inspection process where it is absolutely required to validate certain system functionality and compliance with specific rules (firmware check, etc.). Inspectors may allow the ROBOT to be powered up beyond the parameters above if both criteria below are met.

- A. The ROBOT design requires power or a charged stored energy device in order to confirm that the ROBOT meets volume requirements, and
- B. The Team has included safety interlocks that mitigate unexpected release of such stored energy.

5.5.3. REFEREE Interaction

The Head REFEREE has the ultimate authority in the ARENA during the event, but may receive input from additional sources, e.g. Game Designers, *FIRST* personnel, FTA, and technical staff. The Head REFEREE rulings are final. No event personnel, including the Head REFEREE, will review video, photos, artistic renderings, etc. of any MATCH, from any source, under any circumstances.

- T14** If a DRIVE TEAM needs clarification on a ruling or score, one (1) pre-college student from that DRIVE TEAM should address the Head REFEREE after the FIELD Reset signal (e.g. PLAYER STATION LED strings turn green). A DRIVE TEAM member signals their desire to speak with the Head REFEREE by standing in the corresponding Red or Blue Question Box, which are located on the floor near each end of the scoring table. Depending on timing, the Head REFEREE may postpone any requested discussion until the end of the subsequent MATCH.

5.5.4 YELLOW and RED CARDS

YELLOW CARDS and RED CARDS are used in FRC to manage team and ROBOT behavior that is not in line with the mission of *FIRST*. In

addition to rule violations explicitly listed in The Game section, the Head REFEREE may assign a YELLOW or RED CARD as a result of egregious ROBOT or Team member behavior at the event. A YELLOW or RED CARD is indicated by the Head REFEREE standing in front of the Team's PLAYER STATION and holding a YELLOW and/or RED CARD in the air.

Examples of egregious behavior include, but are not limited to, severe and/or repeated violations of a rule and/or other inappropriate behavior such as repeated use of offensive language or other uncivil conduct.

YELLOW CARDS are additive, meaning that a second YELLOW CARD is automatically converted to a RED CARD. A Team is issued a RED CARD for any subsequent incident in which they receive an additional YELLOW CARD, including earning a second YELLOW card during a single MATCH. A second YELLOW CARD is indicated by the Head REFEREE standing in front of the Team's PLAYER STATION and holding a YELLOW CARD and RED CARD in the air simultaneously after the completion of the MATCH. A Team that has received either a YELLOW CARD or a RED CARD carries a YELLOW CARD into subsequent MATCHES, except as noted below. A RED CARD results in DISQUALIFICATION.

Once a Team receives a YELLOW or RED CARD, its Team number will be presented with a yellow background on the audience screen at the beginning of all subsequent MATCHES as a reminder to the Team, the REFEREES, and the audience that they carry a YELLOW CARD.

Figure 5-3: Audience Screen graphic showing YELLOW and RED CARD Indicators



All YELLOW CARDS are cleared at the conclusion of Qualification MATCHES, providing teams a clean slate at the beginning of Playoff MATCHES.

If a Team receives a RED CARD during the Playoff MATCHES, the entire ALLIANCE receives a RED CARD for that MATCH which results in zero (0) points for that MATCH. If in a Finals MATCH, the ALLIANCE loses the MATCH.

YELLOW and RED CARDS are applied based on the following:

Table 5-3: YELLOW and RED CARD Application

Time YELLOW or RED CARD earned:	MATCH to which CARD is applied:
prior to the start of Qualification MATCHES	Team's first Qualification MATCH
during the Qualification MATCHES	Team's current (or just-completed) MATCH
between the end of Qualification MATCHES and the start of Playoff MATCHES	ALLIANCE'S first Playoff MATCH
during the Playoff MATCHES	ALLIANCE'S current (or just-completed) MATCH

5.5.5 MATCH REPLAYS

Over the course of the Tournament, ARENA faults may occur. These include but are not limited to:

- A. Broken FIELD elements,
- B. Power failure to a portion of the FIELD (tripping the circuit breaker in the PLAYER STATION is not considered a power failure)
- C. Improper activation by the FMS
- D. Errors by FIELD staff

T15 If, in the judgment of the Head REFEREE, an "ARENA fault" occurs that affects the outcome of the MATCH and any team on the affected ALLIANCE(S) in that MATCH desires a replay, the MATCH will be replayed.

NOTE that an ARENA fault that does not affect MATCH outcome in the judgment of the Head REFEREE does not lead to a MATCH replay. Examples include, but are not limited to:

- A. A piece of FIELD plastic falls into the FIELD in the last 5 seconds of a MATCH, far away from any human or ROBOT activity, and in such a way that it does not affect match outcome
- B. Delay in the playing of an ARENA sound
- C. Mismatch between the timer on the Audience Screen and the FIELD Timer

5.5.6 TIMEOUT and BACKUP TEAM Rules

There are no TIMEOUTS in the Practice or Qualification MATCHES.

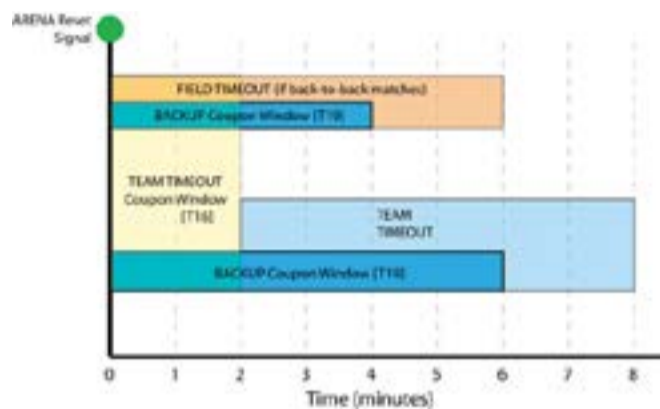
In the Playoff MATCHES, each ALLIANCE will be allotted one (1) TIMEOUT which may be used to pause the Playoff Tournament.

During a TIMEOUT, the ARENA Timer will display the time remaining in the TIMEOUT. Both ALLIANCES will enjoy the complete 6-minute window. If an ALLIANCE completes their repairs before the ARENA Timer expires, the ALLIANCE CAPTAIN is encouraged to inform the Head REFEREE that they are ready to play. If both ALLIANCES are ready to play before the TIMEOUT expires, the next MATCH will start.

During the Playoff MATCHES, if circumstances require an ALLIANCE to play in back-to-back MATCHES, the Head REFEREE will issue a FIELD TIMEOUT to allow Teams to prepare for the next MATCH.

- T16** If an ALLIANCE wishes to call a TIMEOUT, they must submit their TIMEOUT coupon to the Head REFEREE within two (2) minutes of the FIELD reset signal preceding their MATCH. If there is no preceding MATCH, the TIMEOUT coupon must be submitted no later than two (2) minutes before the scheduled MATCH time

Figure 5-4: TIMEOUT Timeline



- T17** There are no cascading TIMEOUTS. If an ALLIANCE calls a TIMEOUT during a FIELD TIMEOUT, the FIELD TIMEOUT will immediately expire and the ALLIANCE'S TIMEOUT will begin.

If an ALLIANCE wishes to call a TIMEOUT during a FIELD TIMEOUT, it must still do so within two (2) minutes of the FIELD reset signal preceding their MATCH, per Rule T16.

- T18** TIMEOUTS are not transferable between ALLIANCES.

While TIMEOUTS are not transferable between ALLIANCES, meaning an ALLIANCE cannot hand their designated TIMEOUT coupon to another ALLIANCE to use, an ALLIANCE may use their own coupon for any purpose they wish.

- T19** If during a TIMEOUT an ALLIANCE CAPTAIN determines that they need to call up a BACKUP TEAM, they must submit their BACKUP TEAM coupon to the Head REFEREE while there are still at least two (2) minutes remaining on the ARENA Timer. After that point, they will not be allowed to utilize the BACKUP TEAM.

Alternatively, an ALLIANCE CAPTAIN may choose to call up a BACKUP TEAM without using their TIMEOUT by informing the Head REFEREE directly within two (2) minutes of the Head REFEREE issuing the FIELD reset signal preceding their MATCH. If there is no preceding MATCH, the BACKUP TEAM coupon must be submitted no later than two (2) minutes before the scheduled MATCH time.

In the case where the ALLIANCE CAPTAIN'S ROBOT is replaced by a BACKUP TEAM, the ALLIANCE CAPTAIN is allowed in the ALLIANCE STATION as a thirteenth ALLIANCE member so they can serve in an advisory role to their ALLIANCE.

The Head REFEREE will not accept the BACKUP TEAM coupon unless it lists the number of the Team whose ROBOT is being replaced, and is initialed by the ALLIANCE CAPTAIN. Once a BACKUP TEAM coupon is submitted and accepted by the Head REFEREE, the BACKUP TEAM coupon may not be withdrawn by the ALLIANCE.

- T20** An ALLIANCE may request neither a TIMEOUT nor a BACKUP TEAM after a Playoff MATCH is stopped by the Head REFEREE (e.g. due to an ARENA fault or a safety issue). The sole exception is if the replay is due to an ARENA fault that rendered a ROBOT inoperable.

If a Playoff MATCH is replayed per T20 the Head REFEREE has the option of calling a FIELD TIMEOUT.

5.5.7 Measurement

The ARENA will be open for at least one (1) hour prior to the start of Qualification MATCHES, during which Teams may survey and/or measure the FIELD. The specific time that the FIELD is open will be communicated to Teams at the event. Teams may bring specific questions or comments to the FTA.

5.5.8 Special Equipment Rules

T21 The only equipment, provided it does not jam or interfere with the remote sensing capabilities of another Team, including vision systems, acoustic range finders, sonars, infrared proximity detectors, etc. (e.g. including imagery that, to a reasonably astute observer, mimics the Vision Guides), that may be brought in to the ALLIANCE STATION are as follows:

- A. the OPERATOR CONSOLE,
- B. non-powered signaling devices,
- C. reasonable decorative items,
- D. special clothing and/or equipment required due to a disability
- E. devices used solely for the purpose of planning or tracking strategy provided they meet all of the following conditions:
 - 1. do not connect or attach to the OPERATOR CONSOLE
 - 2. do not connect or attach to the FIELD or ARENA
 - 3. do not connect or attach to another ALLIANCE member
 - 4. do not communicate with anything or anyone outside of the ARENA.
 - 5. do not include any form of enabled wireless electronic communication (e.g. radios, walkie-talkies, cell phones, Bluetooth communications, Wi-Fi, etc.)
 - 6. do not in any way affect the outcome of a MATCH, other than by allowing PLAYERS to plan or track strategy for the purposes of communication of that strategy to other ALLIANCE members..

5.6 Championship Additions and Exceptions

At the 2015 *FIRST* Championship, Teams are split into eight (8) Subdivisions. Each Subdivision plays a standard Tournament as described in [Section 5.3: Qualification MATCHES](#), [Section 5.4: Playoff MATCHES](#), and [Section 5.5: Tournament Rules](#), with the exception of [Section 5.4.1: ALLIANCE Selection Process](#) and [Section 5.4.2: BACKUP TEAMS](#), to produce the Subdivision Champions. Those eight (8) Subdivision Champions proceed to the Championship Playoffs, on the Einstein FIELDS, to determine the 2015 FRC Champions.

There is no provision for BACKUP TEAMS at the Championship.

5.6.1 Four ROBOT ALLIANCES

Before each Subdivision Playoff Tournament, ALLIANCES will be selected per the process as described in [Section 5.5.3: ALLIANCE Selection Process](#), however the process will continue with a 3rd round of selection as follows.

Round 3: The same method is used for each ALLIANCE CAPTAIN'S third choice except the selection order is reversed again, with ALLIANCE One picking first and ALLIANCE Eight picking last. This process results in eight (8) ALLIANCES of four (4) Teams each.

ALLIANCES may start with any three (3) of the four (4) ROBOTS on their ALLIANCE during Subdivision Playoff MATCHES and during the Championship Playoffs. The list of Teams participating in the MATCH and their selected PLAYER STATIONS is called the LINEUP. One representative from the Team not on the LINEUP is allowed in the ALLIANCE STATION as a thirteenth ALLIANCE member.

The ALLIANCE CAPTAIN must report the LINEUP to the Head REFEREE, or their designee, in writing prior to end of the preceding MATCH (e.g. the LINEUPS for MATCH QF2-1 must be submitted before the end of MATCH QF1-1). If there is no preceding MATCH, the LINEUP is due no later than two (2) minutes before the scheduled MATCH time. The LINEUP will be kept confidential until the FIELD is set for the MATCH, at which point each ALLIANCE'S LINEUP will appear on the Team Signs. Once the LINEUP has been declared, it cannot be changed unless there is a TIMEOUT. If there is a TIMEOUT, the ALLIANCE CAPTAIN may submit a different LINEUP, but must do so while there are still more than two (2) minutes remaining in the TIMEOUT.

EXAMPLE: Four (4) Teams, A, B, C and D, form an ALLIANCE going into the Playoff MATCHES on their Subdivision FIELD. During one of the Playoff MATCHES, Team C's ROBOT becomes inoperable. The ALLIANCE decides to bring in Team D to replace Team C. Team C repairs their ROBOT and may play in any subsequent Playoff MATCHES replacing Teams A, B, or D. All four (4) ALLIANCE members are also eligible to play MATCHES during the Championship Playoffs should the ALLIANCE win the Subdivision Tournament.

If an ALLIANCE fails to submit a LINEUP per the process above, the LINEUP will be the same as the ALLIANCE'S previous MATCH. If an ALLIANCE fails to submit a LINEUP per the process above and the MATCH is their first of the Subdivision Playoffs or the Championship Playoffs, the LINEUP will be the ALLIANCE Lead, first ALLIANCE selection, and second ALLIANCE selection. If any of these three (3) ROBOTS are unable to play, the ALLIANCE must play the MATCH with only two (2) (or even one (1)) ROBOTS.

If a MATCH must be replayed due to an ARENA fault, the LINEUP for the replayed MATCH is the same as the original MATCH. The sole exception is if the ARENA fault rendered a ROBOT inoperable, in which case the LINEUP can be changed.

5.6.2 Championship Pit Crews

Only Team members wearing proper badges are allowed on the ARENA floor. FIRST will distribute these badges to the ALLIANCE CAPTAINS during the ALLIANCE CAPTAIN meeting, which takes place on the Subdivision FIELDS. These badges will provide the necessary access to the ARENA for pit crew members.

Teams should assume they may be chosen for an ALLIANCE and think about the logistics of badge distribution and set a plan prior to the ALLIANCE selection process. It is each ALLIANCE CAPTAIN'S responsibility to get the Team's badges to the pit crew members.

5.6.3 FRC Championship MATCH Bracket

The figure below details the order in which MATCHES are played during the Championship Playoffs. The winning ALLIANCES from each of the Subdivision Fields are abbreviated F1, F2, etc.

In order to allow time between MATCHES for all ALLIANCES, the order of play is as follows:

- **Round 1:** QF1 (Newton vs. Hopper), QF2 (Curie vs. Carver), QF3 (Galileo vs. Carson), QF4, (Archimedes vs. Tesla)
- **Round 2:** QF5 (Newton vs. Carson), QF6 (Curie vs. Tesla), QF7 (Galileo vs. Hopper), QF8 (Archimedes vs. Carver),

In the case where (2) or more ALLIANCES are tied through the fifth order sort described in Table 5-2, the higher position is awarded to the ALLIANCE using a method yet to be determined.

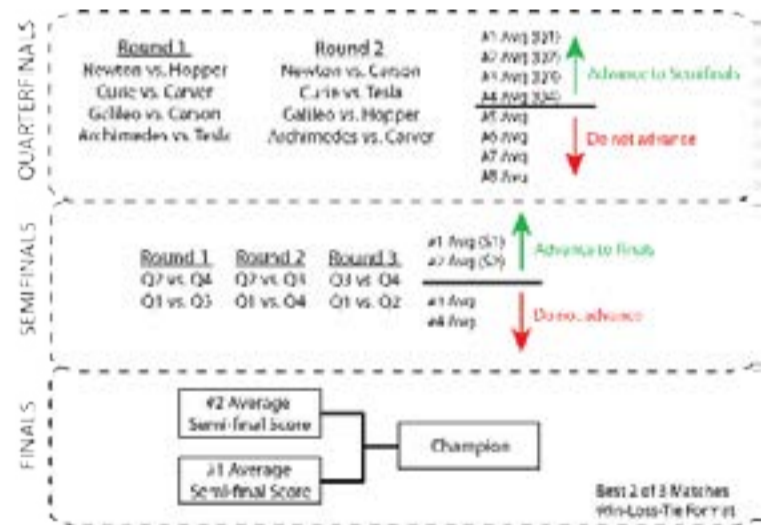
- **Round 1:** SF1 (Q2 vs. Q4), SF2 (Q1 vs. Q3),
- **Round 2:** SF3 (Q2 vs. Q3), SF4 (Q1 vs. Q4)
- **Round 3:** SF5 (Q3 vs. Q4), SF6 (Q1 vs. Q2)

- F1, F2, F3*

Any additional Final MATCHES due to ties*

* IF REQUIRED.

Figure 5-5: Championship Playoff MATCH Bracket



6

Glossary

6.0	Glossary	61
	A - E	62
	F - R	63
	S - Z	64

FIRST®, the FIRST® logo, FIRST® Robotics Competition, FRC®, FIRST® Tech Challenge, Coopertition®, Gracious Professionalism®, and RECYCLE RUSHSM are trademarks of the United States Foundation for Inspiration and Recognition of Science and Technology (FIRST®). FIRST® LEGO® League is a jointly held trademark of FIRST and the LEGO Group. LEGO® is a registered trademark of the LEGO Group. © 2015 FIRST. All rights reserved.

6 GLOSSARY

- ACTIVE DEVICE** – any device capable of dynamically controlling and/or converting a source of electrical energy by the application of external electrical stimulus.
- ALLIANCE** – a set of up to four (4) FRC Teams who play RECYCLE RUSH together.
- ALLIANCE CAPTAIN** – a designated student representative from an ALLIANCE in a Playoff MATCH.
- ALLIANCE STATION** – the area behind the ALLIANCE WALL which contains the three (3) PLAYER STATIONS and two (2) HUMAN PLAYER ZONES and bound by the edges of the carpet and white tape.
- ALLIANCE WALL** – the wall that separates the TEAMS in the ALLIANCE STATION from the FIELD and extends roughly 6 ft. 6 in. (vertically) from the carpet.
- ARENA** – all elements of the game infrastructure required to play RECYCLE RUSH: the FIELD, the ALLIANCE STATIONS, the TOTES, RECYCLING CONTAINERS and LITTER, and all supporting communications, FIELD control, and scorekeeping equipment.
- AUTO** – (aka Autonomous): the fifteen (15) seconds of the MATCH in which ROBOTS operate without any DRIVE TEAM control or input.
- AUTO ZONE** – the infinitely tall volume bound by the GUARDRAILS and carpet between the SCORING PLATFORMS. The AUTO ZONE extends the full width of the FIELD, even though the SCORING PLATFORMS do not.
- BACKSTOP** - an aluminum structure positioned between each SCORING PLATFORM and the GUARDRAILS, primarily used to determine the LEVEL of a scored RECYCLING CONTAINER.
- BACKUP TEAM** – A Team used to replace an inoperable ROBOT on an ALLIANCE during Playoff MATCHES (except at the *FIRST* Championship)
- CHUTE DOOR** – The polycarbonate shield that separates the TOTE CHUTE from the FIELD, and is raised by a HUMAN PLAYER or DRIVER to release a TOTE onto the FIELD from the TOTE CHUTE.
- COACH** – a student or adult Mentor identified as the person wearing the designated “COACH” pin or button during a MATCH.
- COMPONENT** – any part in its most basic configuration, which cannot be disassembled without damaging or destroying the part or altering its fundamental function.
- CONTAINER SET** – an AUTONOMOUS scoring option consisting of three (3) RECYCLING CONTAINERS that are fully contained by the AUTO ZONE at the end of the AUTO period.
- COOPERTITION SET** – a TELEOP scoring option which benefits both ALLIANCES and consists of at least four (4) Yellow TOTES that are fully supported by the STEP, but do not meet the requirements of a COOPERTITION STACK.
- COOPERTITION STACK** – a TELEOP scoring option which benefits both ALLIANCES and consists of at least four (4) Yellow TOTES that are arranged such that they are stacked one on top of another, in a single column, fully supported by the STEP, and the entire structure free of contact from ROBOTS for at least three (3) seconds.
- COTS** – a “Commercial, Off-The-Shelf” COMPONENT or MECHANISM, in its unaltered, unmodified state. A COTS item must be a standard (i.e. not custom order) part commonly available from the VENDOR, available from a non-Team source, and available to all Teams for purchase. Items that are no longer commercially available but are functionally equivalent to the original condition as delivered from the VENDOR are considered COTS and may be used.
- CUSTOM CIRCUIT** – any electrical component of the robot other than motors , pneumatic solenoids, roboRIO, PDP, PCM, VRM, RSL, 120A breaker, motor controllers, relay modules, wireless bridge, or batteries.
- DISABLED** – a state in which a ROBOT has been commanded by the Driver Station to deactivate all outputs.
- DISQUALIFIED** – the status of a Team, as determined by the Head REFEREE, in which their Team receives zero (0) Match points in a qualification MATCH or causes their ALLIANCE to receive zero (0) Match points in a Playoff MATCH.
- DRIVE TEAM** – one (1) COACH, two (2) DRIVERS, and one (1) HUMAN PLAYER from the same FRC Team who are responsible for ROBOT operation during a particular MATCH.
- DRIVER** – a pre-college student DRIVE TEAM member responsible for operating and controlling the ROBOT during a MATCH.

FABRICATED ITEMS – any COMPONENT or MECHANISM that has been altered, built, cast, constructed, concocted, created, cut, heat treated, machined, manufactured, modified, painted, produced, surface coated, or conjured partially or completely into the final form in which it will be used on the ROBOT.

FIELD – a roughly 27 ft. x 54 ft. carpeted area, bounded by and including the GUARDRAILS and ALLIANCE WALLS.

FIELD TIMEOUT – a TIMEOUT called by the Head REFEREE or automatically triggered by the FIELD Management System (if necessary) during a Playoff MATCH.

FOUL – a penalty assessed by a REFEREE which decrements an ALLIANCES score.

GUARDRAILS – a system that borders the length of the FIELD and consists of horizontal pipes, vertical struts, and polycarbonate shields.

HUMAN PLAYER – a pre-college student DRIVE TEAM member primarily responsible for managing and introducing game pieces onto the FIELD throughout the MATCH.

HUMAN PLAYER STATION – an area on either side of each ALLIANCE STATION that connects the PLAYER STATIONS to the GUARDRAILS, and includes a TOTE CHUTE and LITTER CHUTE that are built into a polycarbonate and metal protective wall.

HUMAN PLAYER ZONE – the area bound by the white tape lines, HUMAN PLAYER STATION wall and edges of the carpet.

Kit of Parts (KOP) – the collection of items listed on any *Kit of Parts Checklist*, distributed via *FIRST* Choice, or obtained via a Product Donation Voucher (PDV).

LANDFILL ZONE – the infinitely tall volume bound by the plastic lip of the STEP on the ALLIANCE'S side of the FIELD, the GUARDRAIL on each side, and the landfill line (excluding the tape).

LEVEL – an indicator used to measure how high a scored RECYCLING CONTAINER was placed by a ROBOT.

LINEUP – the list of three (3) Teams and their selected PLAYER STATIONS submitted by an ALLIANCE CAPTAIN to play in a *FIRST* Championship Division Playoff MATCH or a MATCH on the Einstein FIELDS.

LITTER – a game piece used in RECYCLE RUSH and introduced to the FIELD by the ALLIANCE through the LITTER CHUTE or over the ALLIANCE WALL.

LITTER CHUTE – a hole on the wall of the HUMAN PLAYER STATION, directly above the TOTE CHUTE which can be used by an ALLIANCE to introduce LITTER to the FIELD.

MATCH – a two (2) minute and thirty (30) second period of time in which ALLIANCES play RECYCLE RUSH.

MECHANISM – a COTS or custom assembly of COMPONENTS that provide specific functionality on the ROBOT. A MECHANISM can be disassembled (and then reassembled) into individual COMPONENTS without damage to the parts.

OPERATOR CONSOLE – the set of COMPONENTS and MECHANISMS used by the DRIVERS and/or HUMAN PLAYER to relay commands to the ROBOT.

PASSIVE CONDUCTORS – Any device or circuit whose capability is limited to the conduction and/or static regulation of the electrical energy applied to it (e.g. wire, splices, connectors, printed wiring board, etc.).

PLAYER STATION – one (1) of three (3) assigned positions behind an ALLIANCE WALL from where a DRIVE TEAM operates their ROBOT.

RECYCLING CONTAINER – a plastic recycling container game element used in RECYCLE RUSHSM and stacked on scored TOTES by ROBOTS during a MATCH.

RED CARD – a penalty assessed for egregious ROBOT or FRC Team member behavior which results in a team being DISQUALIFIED.

REFEREE – an official who is certified by *FIRST* to enforce the rules of RECYCLE RUSH.

ROBOT – an electromechanical assembly built by an FRC Team to perform specific tasks when competing in RECYCLE RUSH. It includes all of the basic systems required to be an active participant in the game: power, communications, control, and movement. The implementation must obviously follow a design approach intended to play RECYCLE RUSH (e.g. a box of unassembled parts placed on the FIELD or a ROBOT designed to play a different game would not satisfy this definition).

ROBOT SET – an AUTONOMOUS scoring option consisting of all competing ROBOTS from an ALLIANCE being fully contained within their AUTO ZONE at the end of the AUTO period.

SCORING PLATFORM – the elevated wood and HDPE structures, two (2) per ALLIANCE, on which ROBOTS stack TOTES.

STACKED TOTE SET – an AUTONOMOUS scoring option consisting of all three (3) Yellow TOTES from an ALLIANCE being arranged such that, at the end of the AUTO Period, the Yellow TOTES are stacked one on top of another with entire structure contained in the AUTO ZONE and free of contact from ROBOTS.

STAGING ZONE - tape boxes marked by 2 in. gaffers tape (corresponding to the ALLIANCE color) in which the ALLIANCE'S Yellow TOTES and RECYCLING CONTAINERS are staged by the FIELD staff.

STARTING LINE – the line, marked in white tape, located 2 ft. 6 in. behind the ALLIANCE WALL behind which DRIVE TEAM members must stay during AUTO.

STEP – the wooden and plastic structure which bisects the FIELD and prevents ROBOTS from inadvertently crossing onto the opposing ALLIANCE side of the FIELD.

SURROGATE – a Team randomly assigned by the FIELD Management System to play an extra Qualification MATCH.

TELEOP – the final two (2) minutes and fifteen (15) seconds of a MATCH in which ROBOTS may be directly controlled by DRIVERS and/or HUMAN PLAYERS.

TIMEOUT – a period of up to six (6) minutes between MATCHES initiated up to once (1) by an ALLIANCE CAPTAIN to pause Playoff MATCH progression.

TOTE CHUTE – a hole on the wall of the HUMAN PLAYER STATION which resides between the LITTER CHUTE and the carpet of the FIELD and is used by HUMAN PLAYERS, in combination with the CHUTE DOOR, to introduce TOTES to the FIELD.

TOTE SET – an AUTONOMOUS scoring option consisting of all three (3) Yellow TOTES from an ALLIANCE being fully contained in the AUTO ZONE, but not meeting the requirements of a STACKED TOTE SET, at the end of AUTO.

TOTE – a rugged plastic container used by ROBOTS in RECYCLE RUSH and similar in nature to the containers in which Teams received their Kit of Parts.

TRANSPORT CONFIGURATION – a configuration of a ROBOT which does not exceed 2 ft. 4 in. wide x 3 ft. 6 in. deep x 6 ft. 6 in. tall and is used in transferring ROBOTS among competition locations (e.g. the Team's Pit, the Practice Field, Inspection, the ARENA, etc.)

UNPROCESSED LITTER – LITTER which is fully contained by an ALLIANCE'S side of the FIELD, marked in the opposing ALLIANCE'S color, but not scored in their LANDFILL ZONE or scored in a RECYCLING CONTAINER. Each ALLIANCE receives an UNPROCESSED LITTER Bonus for the UNPROCESSED LITTER on the opposite ALLIANCE'S side of the FIELD.

VENDOR – a legitimate business source for COTS items that satisfies all of the following criteria:

- A. has a Federal Tax Identification number. In cases where the VENDOR is outside of the United States, they must possess an equivalent form of registration or license with the government of their home nation that establishes and validates their status as a legitimate business licensed to operate within that country.
- B. is not a “wholly owned subsidiary” of an FRC Team or collection of FRC Teams. While there may be some individuals affiliated with both an FRC Team and the VENDOR, the business and activities of the Team and VENDOR must be completely separable.
- C. must be able to ship any general (i.e., non-*FIRST* unique) product within five business days of receiving a valid purchase request. It is recognized that certain unusual circumstances (such as 1,000 *FIRST* Teams all ordering the same part at once from the same VENDOR) may cause atypical delays in shipping due to backorders for even the largest VENDORS. Such delays due to higher-than-normal order rates are excused.
- D. should maintain sufficient stock or production capability to fill Teams' orders within a reasonable period during the season (less than 1 week). (Note that this criterion may not apply to custom-built items from a source that is both a VENDOR and a fabricator. For example, a VENDOR may sell flexible belting that the Team wishes to procure to use as treads on their drive system. The VENDOR cuts the belting to a custom length from standard shelf stock that is typically available, welds it into a loop to make a tread, and ships it to a Team. The fabrication of the tread takes the VENDOR two weeks. This would be considered a Fabricated Item, and the two weeks ship time is acceptable.) Alternately, the Team may decide to fabricate the treads themselves. To satisfy this criterion, the VENDOR would just have to ship a length of belting from shelf stock (i.e. a COTS item) to the Team within five business days and leave the welding of the cuts to the Team.)
- E. makes their products available to all FRC Teams. VENDOR must not limit supply or make a product available to just a limited number of FRC Teams.

WITHHOLDING ALLOWANCE – a static set of FABRICATED ITEMS that shall not exceed 30 lbs., brought to an event (or Robot Access Period) in addition to the bagged items, to be used to repair and/or upgrade their ROBOT.

YELLOW CARD – a warning issued by the Head REFEREE for egregious ROBOT or FRC Team member behavior.